

FY 24 CONTRACT DOCUMENTS
FOR
MILLING AND OVERLAY OF VARIOUS ROADS
TOWN FUNDED - PROJECT (A)

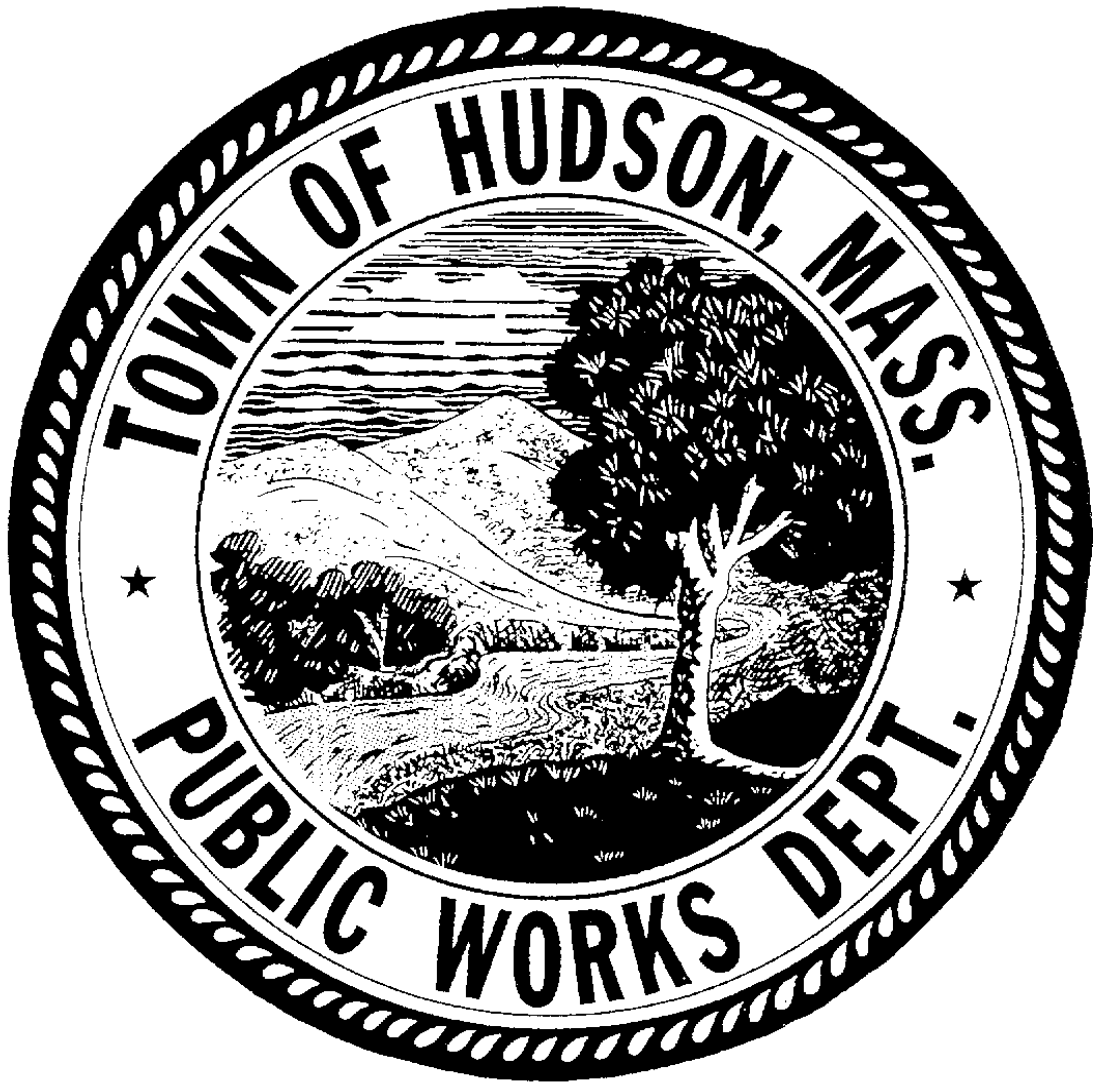

ERIC M RYDER
DIRECTOR

RAJITHA PURIMETLA
ASSISTANT DIRECTOR

TOWN OF HUDSON
DEPARTMENT OF PUBLIC WORKS
1 MUNICIPAL DRIVE
HUDSON MA 01749

TABLE OF CONTENTS

SECTION	TITLE	PAGE
A	ADVERTISEMENT FOR BIDS	A
B	INFORMATION FOR BIDDERS	IB-1 TO 2
	SPECIAL CONDITIONS	
C1	COMMONWEALTH OF MASSACHUSETTS	C-MASS 1 TO 5
C2	EQUAL EMPLOYMENT OPPORTUNITY	C-MASS-EEO-1 TO 4
C3	PREVAILING WAGE RATES	1-39
D	AGREEMENT	D-1 TO 2
E	BID BOND	E-1
F1	MASTER BID ITEM LIST-Project A	1 TO 7
F2	BID PROPOSAL	1 TO 4
G	PAYMENT BOND	G-1 TO 2
H	PERFORMANCE BOND	H-1 TO 2
I	CERTIFICATE OF AUTHORITY	I-1
J	NOTICE TO PROCEED	J-1
K	GENERAL CONDITIONS	K-1 TO 17
L	NOTICE OF AWARD	L-1
M	CHANGE ORDER	M-1
N	ADDENDA _____	WHEN POSTED
O	GENERAL REQUIREMENTS	O
	1A MEASUREMENT AND PAYMENT	O-1A-1
	1B SPECIAL REQUIREMENTS	O-1B-1
	1C SPECIAL PROVISIONS	O-1C-1
	1D WORK QUALITY AND ITEMS	O-1D-1 TO 9
P	APPENDIX	P-1 TO P-11
Q	TAX COMPLIANCE	Q-1
R	PROJECT A – LOCUS and Locations	1 TO 5

ADVERTISEMENT FOR BIDS

The Board of Selectmen of the Town of Hudson, Massachusetts will receive sealed bids for the **MILLING & OVERLAY OF VARIOUS ROADS PROJECT (A)** until 10:00 A.M., on WEDNESDAY, **MARCH 27, 2024** at the Office of the Director of Public Works, 1 Municipal Drive, Hudson, Massachusetts 01749, at which time and place all bids will be publicly opened and read aloud.

A copy of the contract documents for the work may be obtained online under Bid Packages at: <https://www.townofhudson.org/department-public-works> or from the office of the Director, after MARCH 6, 2024 between the hours of 7:30 A.M. and 3:30 P.M.

Prior to downloading the bid documents from the website, it is each Bidder's responsibility to send an email to DPWBIDS@townofhudson.org to be registered as a potential bidder. Only registered bidders will be notified of any addendum. It is the Bidder's responsibility to ensure an accurate and valid email address is provided.

Department of Public Works
One Municipal Drive
Hudson, Massachusetts 01749

Submitted Proposals must be on forms furnished and addressed to the Director of Public Works, 1 Municipal Drive, Hudson, MA 01749.

Estimated length of road under Project A: 5,700 LF

PLEASE MARK ON ENVELOPE PURPOSE OF BID ENCLOSED

Each bid shall be accompanied by a bid security in the amount of 5 percent of the bid price in the form described in the Information for Bidders.

Mass. Department of Transportation Prequalification is a requirement for this project. MassDOT prequalification of contractors with the class of work as Pavement surfacing, for the combined projects (A and B) with a total estimated value of \$750,000 will be required.

Bidder's attention is called to the requirements as to conditions of employment to be observed and minimum state wage rates to be paid under the contract.

NOTE: The Town of Hudson Department of Public Works reserves the right to downsize the project limits if the bid of the lowest responsible bidder is greater than the funds available and allocated to this project.

Eric M Ryder
Director of Public Works

INFORMATION FOR BIDDERS

Bids for the **MILLING & OVERLAY OF VARIOUS ROADS PROJECT (A)** will be received by the Board of Selectmen of the Town of Hudson, Massachusetts (hereinafter called the "Owner"), at the time and place stated in the Advertisement for Bids.

Each bid must be submitted in a sealed envelope, addressed to the Director of Public Works, One Municipal Drive, Hudson, Massachusetts. Each sealed envelope containing a bid must be plainly marked on the outside as **MILLING & OVERLAY OF VARIOUS ROADS PROJECT (A)** with the name of the bidder and their address. If forwarded by mail, the sealed envelope containing the bid must be enclosed in another envelope addressed to the Owner at the Office of the Director of Public Works, One Municipal Drive, Hudson, Massachusetts 01749.

All bids must be made on the bid form included in the specification. All blank spaces for bid prices must be filled in, in ink or typewritten, and the bid form must be fully completed and executed when submitted. Only one copy of the bid form is required.

The Owner may waive any informalities or minor defects or reject any and all bids. Any bid may be withdrawn prior to the above scheduled time for the opening of bids or authorized postponement thereof. Any bid received after the time and date specified shall not be considered. No bidder may withdraw a bid within 60 days, Saturdays, Sundays, and legal holidays excluded, after the actual date of the opening of bids. Should there be reasons why the contract cannot be awarded within the specified period; the time may be extended by mutual agreement between Owner and Bidder.

Bidder must satisfy themselves of the accuracy of the estimated quantities in the bid schedule by examination of the site and a review of the drawings and specifications including addenda. After bids have been submitted, the Bidder shall not assert that there was a misunderstanding concerning the quantities of work or of the nature of the work to be done.

The Owner shall provide to bidder prior to bidding, all information which is pertinent to, and delineates and describes, the land owned and right-of-way acquired or to be acquired.

The contract documents contain the provisions required for the construction of the project. Information obtained from an officer, agent, or employee of the Owner or any other person shall not affect the risks or obligations assumed by the Contractor or relieve him from fulfilling any of the conditions of the contract.

A bid bond, cash, certified check or a treasurer's or cashier's check issued by a responsible bank or trust company, payable to the Town of Hudson, Massachusetts in the amount of 5% of the Project (A) total amount, must be included in the bid submission. After all eligible bid proposals have been compared, the Owner will return the bid deposits of all except the three lowest responsible bidders. When the Agreement is executed, the bid deposits of the two remaining unsuccessful bidders will be returned. The bid deposits of the successful bidder will be retained until the payment bond and performance bond have been executed and approved, after which it will be returned. Projects A and B are funded separately by the Town. Only bids submitted for both projects are considered eligible.

All applicable laws, ordinances and the rules and regulations of all authorities having jurisdiction over construction of the project shall apply to the contract throughout.

Each bidder is responsible for inspecting the site and reading and being thoroughly familiar with the contract documents. The failure or omission of any Bidder to do any of the foregoing shall in no way relieve any Bidder from any obligation in respect to his bid.

The Contractor shall provide at all times proper facilities for access and inspection by Representatives of the Town of Hudson, Massachusetts, Federal, State or any other agency having jurisdiction to all work under this project.

This project is subject to the Safety and Health regulations of the U.S. Department of Labor set forth in 29CFR part 1926, and to the Massachusetts Department of Labor and Industries, Division of Industrial Safety "Rules and Regulations for the Prevention of Accidents in Construction Operations (Industrial Bulletin No. 12)". Contractors shall be familiar with the requirements of these regulations.

This Contract is being bid on under the provisions of Massachusetts General Laws C.30 Section 39M (a). This project is exempt from State Sales and Use or Excise Taxes to the extent allowed by law.

The Contractor shall guarantee all materials and equipment furnished and work performed for a period of one (1) year from the date of substantial completion of the work, that the completed work is free from all defects due to faulty materials or workmanship and the Contractor shall promptly make such corrections as may be necessary by reason of such defects including the repairs or any damage to other parts of the work resulting from such defects. The Owner will give notice of observed defect with reasonable promptness. In the event that the Contractor should fail to make such repairs, adjustments or other work that may be made necessary by such defects, the Owner may do so and charge the Contractor the cost thereby incurred. The Performance Bonds shall remain in full force and effect throughout the guarantee period.

The Contractor's Project Schedule shall include an actual field construction period of not more than **90** on-site calendar days.

Once construction has started, it shall continue uninterrupted until all work is complete and satisfactory to the Engineer, with completion of Project A scope by **July 1, 2024** and completion of Project B scope by **October 15, 2024**. Working day shall be construed as an eight-hour day and not including Saturdays, Sundays, and legal holidays.

Basis for award: The Owner will award the contract to the most responsive and responsible bidder offering the lowest total price for Project A and Project B. The base bid is considered to be the total of Project A and Project B. Hence bids submitted for only Project A or bids submitted for only Project B will be ineligible.

The Owner's obligation under this contract is contingent upon the availability of appropriated funds from which payment for contract purposes can be made. No legal liability on the part of the Owner for any payment may arise until funds are made available to the Contracting Officer for this contract and until the Contractor receives notice of such availability.

Sequence of work:

After a street is cold planed / milled, it shall remain open for a maximum of five (5) working days prior to repaving. After removal of sidewalk, it shall remain open for a maximum of ten (10) working days prior to repaving. However, due to special circumstances, this requirement may be waived by the Town Engineer.

Schedule of Payment: All invoices for Project A must be submitted on a timely manner within the first 15 days after the street is completed and prior to **July 1, 2024**.

A Retainage of 5% shall be held by the Owner on all invoices. This sum shall be held by the Owner until Spring of 2025.

All unit prices quoted herein shall be firm for the duration of the Contract, regardless of any changes in the cost of materials or labor.

Minimum Submission for eligibility: All proposals must comply with the requirements specified in this RFP. To be eligible for evaluation, proposals must (a) be received on or before the due date and time; (b) Include Tax compliance, Certificate of Authority, Bid bonds, Bid Proposal and Forms and Non-Collusion forms; (c) meet the Proposal Format requirements; (d) be complete. Proposals that fail to follow instructions or satisfy these minimum submission requirements will not be reviewed further. The Town will reject any proposal that deviates significantly from the requirements of this RFP.

SPECIAL CONDITIONS - COMMONWEALTH OF MASSACHUSETTS

SECTION 1. METHOD OF PAYING SUBCONTRACTORS

(General Laws, Chapter 30, Section 39F as most recently amended by Chapter 579 of the Acts of 1980)

Every contract awarded pursuant to Section Forty-four A to H, inclusive, of Chapter One Hundred and Forty-Nine (149) shall contain the following subparagraphs (a) through (l) and every contract awarded pursuant to Section Thirty-nine M of Chapter Thirty shall contain the following subparagraphs (a) through (h) and each case those subparagraphs shall be binding between the general contractor and each subcontractor.

- (a) Forthwith after the general contractor receives payment on account of a periodic estimate, the general contractor shall pay to each subcontractor the amount paid for the labor performed and the materials furnished by that subcontractor, less any amount specified in any court proceedings barring such payment and also less any amount claimed due from the subcontractor by the general contractor.
- (b) Not later than the sixty-fifth day after each subcontractor substantially completes his work in accordance with the plans and specifications, the entire balance due under the subcontract less amounts retained by the awarding authority as the estimated cost of completing the incomplete and unsatisfactory items of work, shall be due the subcontractor; and the awarding authority shall pay that amount to the general contractor. The general contractor shall forthwith pay to the subcontractor the full amount received from the awarding authority less any amount specified in any court proceedings barring such payment and also less any amount claimed due from the subcontractor by the general contractor.
- (c) Each Payment made by the awarding authority to the general contractor pursuant to subparagraphs (a) and (b) of this paragraph for the labor performed and the materials furnished by subcontractor shall be made to the general contractor for the account of the subcontractor; and the awarding authority shall take reasonable steps to compel the general contractor to make each such payment to each such subcontractor. If the awarding authority has received a demand for direct payment from a subcontractor for any amount which has already been included in a payment to the subcontractor as provided in subparagraphs (a) and (b), the awarding authority shall act upon the demand as provided in this section.
- (d) If, within seventy days after the subcontractor has substantially completed the subcontract work, the subcontractor has not received from the general contractor the balance due under the subcontract including any amount due for extra labor and materials furnished to the general contractor, less any amount retained by the awarding authority as the estimated cost of completing the incomplete and unsatisfactory items of work, the subcontractor may demand direct payment of that balance from the awarding authority. The demand shall be by a sworn statement delivered to or sent by certified mail to the awarding authority, and a copy shall be delivered to or sent by certified mail to the general contractor at the same time. The demand shall contain a detailed breakdown of the balance due under subcontract and also a statement of the status of completion of the subcontract work. Any demand made after substantial completion of the subcontract work shall be valid even if delivered or mailed prior to the seventieth day after the subcontractor has substantially completed the subcontract work. Within ten days after the subcontractor has delivered or so mailed the demand to the awarding authority and delivered or so mailed a copy to the general contractor, the general contractor may reply to the demand. The reply shall be by a sworn statement delivered to or sent by certified mail to the awarding authority and a copy shall be delivered to or sent by certified mail to the subcontractor at the same time. The reply shall contain a detailed breakdown of the balance due under the subcontract including any amount due for extra labor and materials furnished to the general contractor and of the amount due for each claim made by the general contractor against the subcontractor.
- (e) Within fifteen days after receipt of the demand by the awarding authority, but in no event prior to the seventieth day after substantial completion of the subcontract work, the awarding authority shall make direct subcontract work, the awarding authority shall make direct payment to the subcontractor of the balance due under the subcontract including any amount due for extra labor and materials furnished to the general contractor, less any amount (i) retained by the awarding authority as the estimated cost of completing the incomplete or unsatisfactory items of work, (ii) specified in any court proceedings barring such payment, or (iii) if the reply is not sworn to, or for which the sworn reply does not contain the detailed breakdown required by subparagraph (d). The awarding authority shall make further direct payments to the subcontractor forthwith after the removal of the basis for deductions from direct payments made as provided in parts (i) and (ii) of this subparagraph.

- (f) The awarding authority shall forthwith deposit the amount deducted from a direct payment as provide in part (iii) of subparagraph (e) in an interest-bearing joint subcontractor in bank in Massachusetts selected by the awarding authority or agreed upon by the general contractor and the subcontractor and shall notify the general contractor and the subcontractor of the date of the deposit amount in the account, including accrued interest, as provided in an agreement between the general contractor and the subcontractor or as determined by a decree of a court of competent jurisdiction.
- (g) All direct payments and all deductions from demands for direct payments deposited in an interest-bearing account for accounts in a bank pursuant to subparagraph (f) shall be made out of amount payable to the general contractor at the time of receipt of a demand for direct payment from a subcontractor and out of amounts which later become payable such demands from subcontractors. All direct payments shall discharge the obligation of the awarding authority to the general contractor to the extent of the such payment.
- (h) The awarding authority shall deduct from payments to a general contractor amounts which, together with the deposits in interest-bearing accounts pursuant to subparagraph (f), are sufficient to satisfy all unpaid balances of demands for direct payment received from subcontractors. All such amounts shall be earmarked for such direct payments, and the subcontractors shall have a right in such deductions prior to any claims against such amounts by creditors of the general contractor.
- (i) If the subcontractor does not receive payment as provided in subparagraph (a) or if the general contractor does not submit a periodic estimate for the value of the labor or materials performed or furnished by the subcontractor and the subcontractor does not receive payment for same when due less the deductions provided for in subparagraph (a), the subcontractor may demand direct payment by following the procedure in subparagraph (d) and the general contractor may file a sworn reply as provided in that same subparagraph. A demand made after the first day of the month following that for which the subcontractor performed or furnished the labor and materials for which the subcontractor seeks payment shall be valid even if delivered or mailed prior to the time payment was due on a periodic estimate from the general contractor. Thereafter the awarding authority shall proceed as provided in subparagraph (e), (f), (g) and (h).

SECTION 2 COMPLETION OF PUBLIC WORKS: SEMI-FINAL AND FINAL ESTIMATES: PAYMENTS: EXTRA WORK: DISPUTED ITEMS.

(General Laws, Chapter 30, Section 39G as most recently amended by Chapter 460 of the Acts of 1978).
(Not applicable where the provisions of Chapter 30, Section 39K apply).

Upon substantial completion of the work required by a contract with the Commonwealth, or any agency or political subdivision thereof, for the construction, reconstruction, alteration, remodeling, repair or improvement of public ways, including bridges and other highway structures, sewers and, water mains, airports and other public works, the contractor shall present in writing to the awarding authority its certification that the work has been substantially completed. Within twenty-one days thereafter, the awarding authority shall present to the contractor either a written declaration that the work has been substantially completed.

Within sixty-five days after the effective date of a declaration of a substantial completion, the awarding authority shall prepare and forthwith send to the contractor for acceptance a substantial completion estimate for the quantity and price of the work done and all but one percent retainage on that work including the quantity, price and all but one percent retainage for the undisputed part of each work item and extra work item in dispute but excluding the disputed part thereof, less the estimated cost of completing all incomplete and unsatisfactory work items and less the total periodic payments made to date for the work. The awarding authority also shall deduct from the substantial completion estimate an amount equal to the sum of all demands for direct payment filed by subcontractors and no yet paid to subcontractors or deposited in joint accounts pursuant to Section Thirty-nine F, shall contain any other provision authorizing the awarding authority to deduct any amount by virtue of claims asserted against the contract by subcontractor, material suppliers or others.

If the awarding authority fails to prepare and send to the contractor any substantial completion estimate required by this section on or before the date herein above set forth, the awarding authority will pay to the contractor interest on the amount which would have been due to the contractor pursuant to such substantial completion estimate at the rate of three percentage points above the rediscount rate than charged by the Federal Reserve Bank of Boston from such date to the date on which the awarding authority sends that substantial completion estimate to the contractor for acceptance or to the date of payment therefor, whichever occurs first. The awarding authority shall include the amount of such interest in the substantial completion estimate.

Within fifteen days after the effective date of the declaration of substantial completion, the awarding authority shall send to the contractor by certified mail, return receipt requested, a complete list of all incomplete or unsatisfactory work items, and, unless delayed by causes beyond his control, the contractor shall complete all such work items within forty-five days after the receipt of such list or before the then contract completion date, whichever is later. If the contractor fails to complete such work within such time, the awarding authority may, subsequent to seven days' written notice to the contractor by certified mail, return receipt requested, terminate the contract and complete the incomplete or unsatisfactory work items and charge the cost of same to the contractor.

Within thirty days after receipt by the awarding authority of a notice from the contractor stating that all of the work required by the contract has been completed, the awarding authority shall prepare and forthwith send to the contractor for acceptance a final estimate for the quantity and price of the work done and all retainage on that work less all payments made to date, unless the awarding authority's inspection shows that work items required by the contract remain incomplete or unsatisfactory, or that documentation required by the contract has not been completed. If the awarding authority fails to prepare and send to the contractor the final estimate within thirty days after receipt of notice of completion, the awarding authority shall pay to the contractor interest on the amount which would have been due to the contractor pursuant to such final estimate at the rate hereinabove provided from the thirtieth day after such completion until the date on which the awarding authority sends the final estimate to the contractor for acceptance or the date of payment therefore, authority's inspection shows that no work items required by the contract remain incomplete or unsatisfactory. Interest shall not be paid hereunder on amounts for which interest is required to be paid in connection with the substantial completion estimate as hereinabove provided. The awarding authority shall include the amount of the interest required to be paid hereunder in the final estimate.

The awarding authority shall pay the amount due pursuant to any periodic, substantial completion or final estimate within thirty-five days after receipt of written acceptance for such estimate at the rate hereinabove provide from that thirty-fifth day to the date of payment. In the case of periodic payments, the contracting authority may deduct from its payment a retention based on its estimate of the fair value of its claims against the contractor, retention for in accordance with the provisions of Section Thirty-nine F of Chapter Thirty; provided, that a five percent value of all items that are planted in the ground shall be deducted from the periodic payments until final acceptance.

No periodic, substantial completion or final estimate or acceptance or payment thereof shall bar a contractor from reserving all rights to dispute the quantity and amount of, or the failure of the awarding authority to approve a quantity and amount of, all or part of any work item or extra work item.

Substantial completion, for the purposes of this section, shall mean either that the work required by the contract has been completed except for work having a contract price of less than one percent of the then adjusted total contract price, or substantially all of the work has been completed and opened to public use except for minor incomplete or unsatisfactory work items that do not materially impair the usefulness of the work required by the contract.

SECTION 3. CLAIMS FOR UNFORESEEN CONDITIONS

(General Laws, Chapter 30, Section 39N as most recently amended by Chapter 774 of the Acts of 1972)

Every contract subject to Section Forty-four A of Chapter One Hundred and Forty-nine or subject to Section Thirty-nine M of Chapter Thirty shall contain the following paragraph in its entirety and an awarding authority may adopt reasonable rules or regulations in conformity with that paragraph concerning the filing, investigation and settlement of such claims:

If, during the progress of the work, the contractor or the awarding authority discovers that the actual subsurface or latent physical conditions encountered at the site differ substantially or materially from those shown on the plans or indicated in the contract documents either the contractor and the contracting authority may request an equitable adjustment in the contract price of the contract applying to work affected by the differing site conditions. A request delivered by the party making such claim to the other party as soon as possible after such conditions are discovered. Upon receipt of such a claim from a contractor, or upon its own initiative, the contracting authority shall make an investigation of such physical conditions, and if they differ substantially or materially from those shown on the plans or indicated in the contract documents or from those ordinarily encountered and generally recognized as inherent in work of the character provide for in the plans and contract documents and are of such a nature as to cause an increase or decrease in the cost of performance of the work or a change in the construction methods required for the performance of the work which results in an increase or decrease in the cost of the work, the contracting authority shall make an equitable adjustment in the contract price and the contract shall be modified in writing accordingly.

SECTION 4. CLAIMS FOR DELAYS

(General Laws, Chapter 30, Section 390 as added by Chapter 116 of the Acts of 1973)

Every contract subject to the provisions of Section Thirty-nine M of this chapter or subject to Section Forty-four A of Chapter One Hundred Forty-nine shall contain the following provisions (a) and (b) in their entirety and, in the event a suspension, delay, interruption or failure to act of the awarding authority increases the cost of performance to any subcontractor, that subcontractor shall have the same rights against the general contractor for payment for an increase in the cost of his performance as provisions (a) and (b) give the general contractor against the awarding authority, but nothing in provisions (a) and (b) shall in any way change, modify or alter any other rights which the general contractor of the subcontractor may have against each other.

- (a) The awarding authority may order the general contractor in writing to suspend, delay, or interrupt all or any part of the work for such period of time as it may determine to be appropriate for the convenience of the awarding authority; provide however, that if there is a suspension, delay or interruption for fifteen days or more or due to a failure of the awarding authority to act within the time specified in this contract, the awarding authority shall make an adjustment in the contract price for any increase in the cost to performance of this contract but shall not include any profit to the general contractor on such increase; and provide further, that the awarding authority shall not make any adjustment in the contract price under this provision for any suspension, delay, interruption or failure to act to the extent that such is due any cause for which this contract provides for an equitable adjustment of the contract price under any other contract provisions.
- (b) The general contractor must submit the amount of a claim under provision (a) to the awarding authority in writing, as soon as practicable after the end of the suspension, delay, interruption or failure to act and, in any event, not later than the date of final payment under this contract and, except for costs due to a suspension order, the awarding authority shall not approve any costs in the claim incurred more than twenty days before the general contractor notified the awarding authority in writing of the act of failure to act involved in the claim.

SECTION 5. DECISIONS AND APPROVALS BY ENGINEER OR ARCHITECT

(General Laws, Chapter 30, Section 39P, as added by Chapter 116 of the Acts of 1973)

Every contract subject to Section Thirty-nine M of this chapter or Section Forty-four A of Chapter One Hundred Forty-nine which requires the awarding authority, any official, its architect or engineer to make a decision on interpretation of the specifications, approval of equipment, material or any other approval, or progress of the work, shall require that the decision be made promptly and, in any event, no later than thirty days after the written submission for decision; but if such decision requires extended investigation and study, the awarding authority, the official, architect or engineer shall, within thirty days after the receipt of the submission, give the party making the submission written notice of the reasons why the decision cannot be made within the thirty day period and the date by which the decision will be made.

SECTION 6. PREFERENCE IN EMPLOYMENT, WAGES

(General Laws, Chapter 149 Section 26 as most recently amended by Chapter 296 of the Acts of 1967).

In the employment of mechanics and apprentices, teamsters, chauffeurs and laborers in the construction of public works by the Commonwealth, or by a county, town or district, or by persons contracting or subcontracting for such works, preference shall first be given to citizens of the Commonwealth who have been residents of the Commonwealth for at least six months at the commencement of their employment, who are male veterans as defined in clause Forty-third of Section Seven of Chapter Four, and who are qualified to perform the work to which the employment relates; and secondly, to citizens of the Commonwealth generally who have been residents of the Commonwealth for at least six months at the commencement of their employment, and if they cannot be obtained in sufficient numbers, then to citizens of the United States, and every contract for such work shall contain a provision to this effect. Each country, town or district in the construction of public works, or person's preference to veterans and citizens who are residents of such country, town or district. The rate per hour of the wages paid to said mechanics and apprentices, teamsters, chauffeurs and laborers in the construction of public works shall not be less than the rate or rates of wages to be determined by the commissioner as hereinafter provided; provided, that the wages paid to laborers employed on said works shall not be less than those paid to laborers in the municipal service of the town or towns where said works are being constructed; provided, further, that where the same public works is to be constructed in two or more towns, the wages paid to laborers shall not be less than those paid to laborers in the municipal service of the town paying the highest rate; provided, further, that if, in any of the towns where the works are to be constructed, a wage rate or wage rates have been established in certain trades and occupations by collective agreements or understandings between organized labor and employers, the rate or rates to be paid on said works shall not be less than the rates so established; provided, further that in towns where no such rate or rates have been so established, the wages paid to mechanics and apprentices, teamster, chauffeurs and laborers on public works, shall not be less than the wages paid to the employees in the same trades and occupations by private employers

engaged in the construction industry. This section shall also apply to regular employees of the Commonwealth or of a county, town or district, when such employees are employed in the construction, addition to or alteration of public buildings for which special appropriation of more than One Thousand Dollars are provided. Payments by employers to health and welfare plans, pension plans and supplementary unemployment benefit plans under collective bargaining agreements or understandings between organized labor and employers shall be included for the purpose of establishing minimum wage rates as herein provide.

SECTION 7. HOURS OF WORK

(General Laws, Chapter 149 Section 34 as most recently amended by Chapter 680 of the Acts of 1947)

Every contract, except for the purchase of material or supplies, involving the employment of laborers, workmen, mechanics, foremen or inspectors, to which the Commonwealth or any county or town, subject to Section Thirty, as a party, shall contain a stipulation that no laborer, workman, mechanic, foreman or inspector working within the Commonwealth, in the employ of the contractor, subcontractor or other person doing or contracting to do the whole or a part of the work contemplated by the contract, shall be required or permitted to work more than eight hours in any one day or more than forty-eight hours in any one week, or more than six days in any one week, except in case of emergency, or, in case any town subject to Section Thirty-one is a party to such a contract, more than eight hours in any one day, except as aforesaid, provided, that in contracts entered into by the department of public works for the construction or reconstruction of highways there may be inserted in said stipulation a provision that said department, or any contractor or subcontractor for said department, may employ laborers, workmen, mechanics, foremen and inspectors for more than eight hours in any one day in such construction or reconstruction when, in the opinion of so requires. Every such contract no containing the aforesaid stipulation shall be null and void.

SECTION 8. MINIMUM WAGE RATES

In compliance with Massachusetts Laws, Chapter 149, Sections 26 to 27D inclusive, classifications of Labor and Minimum Wage Rates applying thereto have been established by the Department of Labor and Industries of the Commonwealth of Massachusetts and are included in these specifications, hereinafter:

THE COMMONWEALTH OF MASSACHUSETTS
SUPPLEMENTAL EQUAL EMPLOYMENT OPPORTUNITY
ANTI-DISCRIMINATION AND AFFIRMATIVE ACTION PROGRAM

- I. For purposes of this contract, "minority" refers to Asian-Americans, Blacks, Spanish Surnamed Americans, North American Indians, and Cape Verdeans. "Commission" refers to the Massachusetts Commission Against Discrimination.
- II. During the performance of this contract, the Contractor and all of (his) subcontractors (hereinafter collectively referred to as the Contractor), for himself, his assignees, and successors in interest, agree as follows:
 1. In connection with the performance of work under this contract, the Contractor shall not discriminate against any employee or applicant for employment because of race, color, religious creed, national origin, age or sex. The aforesaid provision shall include, but not be limited to, the following: employment upgrading, demotion, or transfer; recruitment advertising; recruitment layoff; termination; rates of pay or other forms of compensation; conditions or privileges of employment; and selection for apprenticeship. The Contractor shall post hereafter in conspicuous places, available for employees and applicants for employment, notices to be provided by the Commission setting forth the provisions of the Fair Employment Practices Law of the Commonwealth (M.G.L. Chapter 151B).
 2. In connection with the performance of work under this contract, the Contractor, shall undertake in good faith affirmative action measures designed to eliminate any discriminatory barriers in the terms and conditions of employment on the grounds of race, color, religious creed, national origin, age or sex, and to eliminate and remedy any effects of such discrimination in the past. Such affirmative action shall entail positive and aggressive measures to ensure equal opportunity in the areas of hiring, upgrading, demotion or transfer, recruitment, layoff or termination, rate of compensation, and in-service or apprenticeship training programs. This affirmative action shall include all action required to guarantee equal employment opportunity for all persons, regardless of race, color, religious creed, national origin, age, or sex. A purpose of this provision is to ensure to the fullest extent possible an adequate supply of skilled tradesmen for this and future Commonwealth public construction projects.
- III. As part of his obligation of remedial action under the foregoing section, the Contractor shall maintain on this project a not less than five (5) percent ratio of minority employee man hours to total man hours in each job category including but not limited to bricklayers, carpenter, cement masons, electricians, I ironworkers, operating engineers, and those "classes of work" enumerated in Section 44C of Chapter 149 of the Massachusetts General Laws.
 1. In the hiring of minority journeymen, apprentices, trainees and advanced trainees, the Contractor shall rely on referrals from a multi-employer affirmative action program approved by the Commission, traditional referral methods utilized by the construction industry, and referrals from agencies, not more than three in number at any one time, designated by the Liaison Committee or the Commission.
- IV.
 1. The discretion of the Commission there may be established for the life of this contract a body to be known as the Liaison Committee. The Liaison Committee shall be composed of one representative each from the agency or agencies administering this project, hereinafter called the administering agency, the Commission and such other representatives as may be designated by the Commission in conjunction with the administering agency.
 2. The Contractor (or his agent, if any, designated by him as the on-site equal employment opportunity officer) shall recognize the Liaison Committee as an affirmative action body, and shall establish a continuing working relationship with the Liaison Committee, consulting with the Liaison Committee on all matters related to minority recruitment, referral, employment and training.
 3. The Contractor shall prepare projected manning tables on a quarterly basis. These shall be broken down into projections, by week, or workers required in each trade. Copies shall be furnished one week in advance of the commencement of the period covered, and also when update, to the Commission and Liaison Committee.
 4. Records of employment referral orders, prepared by the Contractor, shall be made available to the Commission and to the Liaison Committee on request.

5. The Contractor shall prepare weekly reports in a form approved by the Commission of hours worked in each trade by each employee, identified as minority or non-minority. Copies of these shall be provided at the end of each such week to the Commission and to the Liaison Committee.
- V. If the Contractor shall use any subcontractor on any work performed under this contract, he shall take affirmative action to negotiate with qualified minority subcontractors. This affirmative action shall cover both pre-bid and post-bid periods. It shall include notification to the Office of Minority Business Assistance (within the Executive Office of Communities and Development) or its designee, while bids are in preparation, of all products, work or services for which the Contractor intends to negotiate bids.
- VI. In the employment of journeymen, apprentices, trainees and advanced trainees, the Contractor shall give preference, first, to citizens of the Commonwealth who have served in the armed forces of the United States in time of war and have been honorably discharged therefrom or released from active duty therein, and who are qualified to perform the work to which the employment relates, and, secondly, to citizens of the Commonwealth generally, and if such cannot be obtained in sufficient numbers, then to the citizens of the United States.
- VII. A designee of the Commission and a designee of the Liaison Committee shall each have right of access to the construction site.

VIII. COMPLIANCE WITH REQUIREMENTS

The Contractor shall comply with the provisions of Executive Order No. 74, as amended by Executive Order No. 116 dated May 1, 1975, and of Chapter 151B as amended, of the Massachusetts General Laws, both of which are herein incorporated by reference and made a part of this contract.

IX. NON-DISCRIMINATION

The Contractor, in the performance of all work after award, and prior to completion of the contract work, will not discriminate on grounds of race, color, religious creed, national origin, age or sex in employment practices, in the selection or retention of subcontractors, or in the procurement of materials and rentals of equipment.

X. SOLICITATIONS FOR SUB-CONTRACTS AND FOR THE PROCUREMENT OF MATERIALS AND EQUIPMENT

In all solicitations either by competitive bidding or negotiation made by the Contractor either for work to be performed under a subcontract or for the procurement of materials or equipment, each potential subcontractor or supplier shall be notified in writing by the Contractor of the Contractor's obligations under this contract relative to non-discrimination and affirmative action.

XI. BIDDERS CERTIFICATION REQUIREMENT

1. The bidder's certification form currently in use will be deleted from all future bid documents.
2. The following certification statement will be inserted in the bid document just above the bidder's signature, as a substitute for the present bidder certification form:

"The bidder hereby certifies he shall comply with the minority manpower ration and specific action steps contained in the appendix EEO attached hereto, including compliance with the minority Contractor compliance specified in Section V of said appendix. The Contractor receiving the award of the contract shall be required to obtain from each of its subcontractors and submit to the contracting or administering agency prior to the performance of any work under said contract a certification by said subcontractor, regardless of tier, that it will comply with the minority manpower ration and specific affirmative action steps contained in the appendix EEO."

XII. CONTRACTOR'S CERTIFICATION

The Contractor's certification form must be signed by all successful low bidders(s) prior to award by the contracting agency. (See attachment).

XIII. COMPLIANCE-INFORMATION, REPORTS AND SANCTIONS

1. The Contractor will provide all information and reports required by the administering agency or the Commission on instructions issued by either of them and will permit access to its facilities and any books, records, accounts and other sources of information which may be determined by the Commission to affect the employment of personnel. This provision shall apply only to information pertinent to the Commonwealth's supplementary affirmative action contract requirement. Where information required is in the exclusive possession of another who fails or refuses to furnish this

information, the Contractor shall so certify to the administering agency or the Commission as appropriate and shall set forth what efforts he has made to obtain the information.

2. Whenever the administering agency, the Commission, or the Liaison Committee believes the General Contractor or any subcontractor may not be operating in compliance with the terms of this Section, the Commission directly, or through its designated agent, shall conduct an appropriate investigation, and may confer with the parties, to determine if such Contractor is operating in compliance with the terms of this Section. If the Commission or its agent finds the General Contractor or any subcontractor not in compliance, it shall make a preliminary report on non-compliance, and notify such Contractor in writing of such steps as will in the judgment of the Commission or its agent bring such contract into compliance. In the event that such Contractor fails or refuses to fully perform such steps, the Commission shall make a final report of non-compliance, and recommend to the administering agency the imposition of one or more of the sanctions listed below. If however, the Commission believes the General Contractor or any subcontractor has taken or is taking every possible measure to achieve compliance, it shall not make a final report of non-compliance. Within fourteen days of the receipt of the recommendations of the Commission, the administering agency shall move to impose one or more of the following sanctions, as it may deem appropriate to attain full and effective enforcement:
 - a. The recovery by the administering agency from the General Contractor of 1/100 of 1% of the contract award price or \$1000 whichever sum is greater, in the nature of liquidated damages or, if a subcontractor is in non-compliance, the recovery by the administering agency from the General Contractor, to be assessed by the General Contractor as a back charge against the subcontractor, of 1/10 of 1% of the subcontract price, or \$400 whichever sum is greater, in the nature of liquidated damages, for each week that such party fails or refuses to comply;
 - b. The suspension of any payment or part thereof due under the contract until such time as the General Contractor or any subcontractor is able to demonstrate his compliance with the terms of the contract;
 - c. The termination, or cancellation, of the contract, in whole or in part, unless the General Contractor or any subcontractor is able to demonstrate within a specified time his compliance with the terms of the contract;
 - d. The denial to the General Contractor or any subcontractor of the right to participate in any future contracts awarded by the administering agency for a period of up to three years.
3. If at any time after the imposition of one or more of the above sanctions a Contractor is able to demonstrate that he is in compliance with this Section, he may request the administering agency, in consultation with the Commission, to suspend the sanctions conditionally, pending a final determination by the Commission as to whether the Contractor is in compliance. Upon final determination of the Commission, the administering agency, based on the recommendation of the Commission, shall either lift the sanctions or reimpose them.
4. Sanctions enumerated under Sections XI-2 shall not be imposed by the administering agency except after an adjudicatory proceeding, as that term is used M.G.L. c. 30A, has been conducted. No investigation by the Commission or its agent shall be initiated without prior notice to the Contractor.

XIV. SEVERABILITY

The provisions of this section are severable, and if any of these provisions shall be held unconstitutional by any court of competent jurisdiction, the decision of such court shall not affect or impair any of the remaining provisions.

A. CONTRACTORS' CERTIFICATION

A Contractor will not be eligible for award of a contract unless such Contractor has submitted the following certification, which is deemed a part of the resulting contract:

CONTRACTOR'S CERTIFICATION

(CONTRACTOR)

- 1. intends to use the following listed construction trades in the work under the contract

_____ ; and

- 2. will comply with the minority manpower ration and specific affirmative action steps contained herein; and
- 3. will obtain from each of its subcontractors and submit to the contracting or administering agency prior to the award of any subcontract under this contract the subcontractor certification required by these bid conditions.

(Signature of authorized representative of Contractor)

B. SUBCONTRACTORS' CERTIFICATION

Prior to the award of any subcontract, regardless of tier, the prospective subcontractor must execute and submit to the Prime Contractor the following certification, which will be deemed a part of the resulting subcontract;

SUBCONTRACTORS' CERTIFICATION

_____ certifies that;

- 1. intends to use the following listed construction trades in the work under the subcontract

_____ and

- 2. will comply with the minority manpower ration and specific affirmative action steps contained herein; and
- 3. will obtain from each of the subcontractors prior to the award of any subcontract under this subcontract the subcontractor certification required by these bid conditions.

(Signature of authorized representative of subcontractor)

In order to ensure that the said subcontractors' certification becomes a part of all subcontracts under the prime contract, no subcontract shall be executed until an authorized representative of the state agency (or agencies) administering this project subcontract, regardless of tier. Any subcontract executed without such written approval shall be void.



MAURA HEALEY
Governor

KIM DRISCOLL
Lt. Governor

THE COMMONWEALTH OF MASSACHUSETTS
EXECUTIVE OFFICE OF LABOR AND WORKFORCE DEVELOPMENT
DEPARTMENT OF LABOR STANDARDS

Prevailing Wage Rates

As determined by the Director under the provisions of the
Massachusetts General Laws, Chapter 149, Sections 26 to 27H

LAUREN JONES
Secretary

MICHAEL FLANAGAN
Director

Awarding Authority: Town of Hudson
Contract Number: **City/Town:** HUDSON
Description of Work: Mill and Overlay of various roads in the Town of Hudson, Project A is Town funded and Project B would be Chapter 90 funded.
Job Location: 1 Municipal Drive

Information about Prevailing Wage Schedules for Awarding Authorities and Contractors

- **The wage rates will remain in effect for the duration of the project, except in the case of multi-year public construction projects. For construction projects lasting longer than one year, awarding authorities must request an updated wage schedule no later than two weeks before the anniversary of the date the contract was executed by the awarding authority and the general contractor.** For multi-year CM AT RISK projects, the awarding authority must request an annual update no later than two weeks before the anniversary date, determined as the earlier of: (a) the execution date of the GMP Amendment, or (b) the execution date of the first amendment to permit procurement of construction services. The annual update requirement is not applicable to 27F "rental of equipment" contracts. **The updated wage schedule must be provided to all contractors, including general and sub-contractors, working on the construction project.**
- This wage schedule applies only to the specific project referenced at the top of this page and uniquely identified by the "Wage Request Number" on all pages of this schedule.
- An Awarding Authority must request an updated wage schedule if it has not opened bids or selected a contractor within 90 days of the date of issuance of the wage schedule. For CM AT RISK projects (bid pursuant to G.L. c.149A), the earlier of: (a) the execution date of the GMP Amendment, or (b) the bid for the first construction scope of work must be within 90-days of the wage schedule issuance date.
- The wage schedule shall be incorporated in any advertisement or call for bids for the project as required by M.G.L. c. 149, § 27. The wage schedule shall be made a part of the contract awarded for the project. The wage schedule must be posted in a conspicuous place at the work site for the life of the project in accordance with M.G.L. c. 149 § 27. The wages listed on the wage schedule must be paid to employees performing construction work on the project whether they are employed by the prime contractor, a filed sub-bidder, or a sub-contractor.
- Apprentices working on the project are required to be registered with the Massachusetts Division of Apprentice Standards (DAS). Apprentices must keep their apprentice identification card on their persons during all work hours on the project. An apprentice registered with DAS may be paid the lower apprentice wage rate at the applicable step as provided on the prevailing wage schedule. **Any apprentice not registered with DAS regardless of whether they are registered with another federal, state, local, or private agency must be paid the journeyworker's rate.**
- Every contractor or subcontractor working on the construction project must submit weekly payroll reports and a Statement of Compliance directly to the awarding authority by mail or email and keep them on file for three years. Each weekly payroll report must contain: the employee's name, address, occupational classification, hours worked, and wages paid. Do not submit weekly payroll reports to DLS. For a sample payroll reporting form go to <http://www.mass.gov/dols/pw>.
- Contractors with questions about the wage rates or classifications included on the wage schedule have an affirmative obligation to inquire with DLS at (617) 626-6953.
- Contractors must obtain the wage schedules from awarding authorities. Failure of a contractor or subcontractor to pay the prevailing wage rates listed on the wage schedule to all employees who perform construction work on the project is a violation of the law and subjects the contractor or subcontractor to civil and criminal penalties.
- Employees not receiving the prevailing wage rate set forth on the wage schedule may file a complaint with the Fair Labor Division of the office of the Attorney General at (617) 727-3465.

Classification	Effective Date	Base Wage	Health	Pension	Supplemental Unemployment	Total Rate
Construction						
(2 AXLE) DRIVER - EQUIPMENT <i>TEAMSTERS JOINT COUNCIL NO. 10 ZONE B</i>	01/01/2024	\$38.95	\$15.07	\$18.67	\$0.00	\$72.69
	06/01/2024	\$39.95	\$15.07	\$18.67	\$0.00	\$73.69
	12/01/2024	\$39.95	\$15.07	\$20.17	\$0.00	\$75.19
	01/01/2025	\$39.95	\$15.57	\$20.17	\$0.00	\$75.69
	06/01/2025	\$40.95	\$15.57	\$20.17	\$0.00	\$76.69
	12/01/2025	\$40.95	\$15.57	\$21.78	\$0.00	\$78.30
	01/01/2026	\$40.95	\$16.17	\$21.78	\$0.00	\$78.90
	06/01/2026	\$41.95	\$16.17	\$21.78	\$0.00	\$79.90
	12/01/2026	\$41.95	\$16.17	\$23.52	\$0.00	\$81.64
	01/01/2027	\$41.95	\$16.77	\$23.52	\$0.00	\$82.24
(3 AXLE) DRIVER - EQUIPMENT <i>TEAMSTERS JOINT COUNCIL NO. 10 ZONE B</i>	01/01/2024	\$39.02	\$15.07	\$18.67	\$0.00	\$72.76
	06/01/2024	\$40.02	\$15.07	\$18.67	\$0.00	\$73.76
	12/01/2024	\$40.02	\$15.07	\$20.17	\$0.00	\$75.26
	01/01/2025	\$40.02	\$15.57	\$20.17	\$0.00	\$75.76
	06/01/2025	\$41.02	\$15.57	\$20.17	\$0.00	\$76.76
	12/01/2025	\$41.02	\$15.57	\$21.78	\$0.00	\$78.37
	01/01/2026	\$41.02	\$16.17	\$21.78	\$0.00	\$78.97
	06/01/2026	\$42.02	\$16.17	\$21.78	\$0.00	\$79.97
	12/01/2026	\$42.02	\$16.17	\$23.52	\$0.00	\$81.71
	01/01/2027	\$42.02	\$16.77	\$23.52	\$0.00	\$82.31
(4 & 5 AXLE) DRIVER - EQUIPMENT <i>TEAMSTERS JOINT COUNCIL NO. 10 ZONE B</i>	01/01/2024	\$39.14	\$15.07	\$18.67	\$0.00	\$72.88
	06/01/2024	\$40.14	\$15.07	\$18.67	\$0.00	\$73.88
	12/01/2024	\$40.14	\$15.07	\$20.17	\$0.00	\$75.38
	01/01/2025	\$40.14	\$15.57	\$20.17	\$0.00	\$75.88
	06/01/2025	\$41.14	\$15.57	\$20.17	\$0.00	\$76.88
	12/01/2025	\$41.14	\$15.57	\$21.78	\$0.00	\$78.49
	01/01/2026	\$41.14	\$16.17	\$21.78	\$0.00	\$79.09
	06/01/2026	\$42.14	\$16.17	\$21.78	\$0.00	\$80.09
	12/01/2026	\$42.14	\$16.17	\$23.52	\$0.00	\$81.83
	01/01/2027	\$42.14	\$16.77	\$23.52	\$0.00	\$82.43
ADS/SUBMERSIBLE PILOT <i>PILE DRIVER LOCAL 56 (ZONE 1)</i>	08/01/2020	\$103.05	\$9.40	\$23.12	\$0.00	\$135.57
For apprentice rates see "Apprentice- PILE DRIVER"						
AIR TRACK OPERATOR <i>LABORERS - ZONE 2</i>	12/01/2023	\$38.61	\$9.65	\$17.14	\$0.00	\$65.40
For apprentice rates see "Apprentice- LABORER"						
AIR TRACK OPERATOR (HEAVY & HIGHWAY) <i>LABORERS - ZONE 2 (HEAVY & HIGHWAY)</i>	12/01/2023	\$38.61	\$9.65	\$17.14	\$0.00	\$65.40
	06/01/2024	\$39.94	\$9.65	\$17.14	\$0.00	\$66.73
	12/01/2024	\$41.27	\$9.65	\$17.14	\$0.00	\$68.06
	06/01/2025	\$42.66	\$9.65	\$17.14	\$0.00	\$69.45
	12/01/2025	\$44.04	\$9.65	\$17.14	\$0.00	\$70.83
	06/01/2026	\$45.48	\$9.65	\$17.14	\$0.00	\$72.27
	12/01/2026	\$46.92	\$9.65	\$17.14	\$0.00	\$73.71
For apprentice rates see "Apprentice- LABORER (Heavy and Highway)"						

Classification	Effective Date	Base Wage	Health	Pension	Supplemental Unemployment	Total Rate
ASBESTOS REMOVER - PIPE / MECH. EQUIPT. <i>HEAT & FROST INSULATORS LOCAL 6 (BOSTON)</i>	12/01/2023	\$40.80	\$14.50	\$11.05	\$0.00	\$66.35
	06/01/2024	\$41.80	\$14.50	\$11.05	\$0.00	\$67.35
	12/01/2024	\$42.80	\$14.50	\$11.05	\$0.00	\$68.35
	06/01/2025	\$43.80	\$14.50	\$11.05	\$0.00	\$69.35
	12/01/2025	\$44.80	\$14.50	\$11.05	\$0.00	\$70.35
ASPHALT RAKER <i>LABORERS - ZONE 2</i>	12/01/2023	\$38.11	\$9.65	\$17.14	\$0.00	\$64.90
For apprentice rates see "Apprentice- LABORER"						
ASPHALT RAKER (HEAVY & HIGHWAY) <i>LABORERS - ZONE 2 (HEAVY & HIGHWAY)</i>	12/01/2023	\$38.11	\$9.65	\$17.14	\$0.00	\$64.90
	06/01/2024	\$39.44	\$9.65	\$17.14	\$0.00	\$66.23
	12/01/2024	\$40.77	\$9.65	\$17.14	\$0.00	\$67.56
	06/01/2025	\$42.16	\$9.65	\$17.14	\$0.00	\$68.95
	12/01/2025	\$43.54	\$9.65	\$17.14	\$0.00	\$70.33
	06/01/2026	\$44.98	\$9.65	\$17.14	\$0.00	\$71.77
	12/01/2026	\$46.42	\$9.65	\$17.14	\$0.00	\$73.21
For apprentice rates see "Apprentice- LABORER (Heavy and Highway)"						
ASPHALT/CONCRETE/CRUSHER PLANT-ON SITE <i>OPERATING ENGINEERS LOCAL 4</i>	12/01/2023	\$55.03	\$15.00	\$16.40	\$0.00	\$86.43
	06/01/2024	\$56.33	\$15.00	\$16.40	\$0.00	\$87.73
	12/01/2024	\$57.78	\$15.00	\$16.40	\$0.00	\$89.18
	06/01/2025	\$59.08	\$15.00	\$16.40	\$0.00	\$90.48
	12/01/2025	\$60.53	\$15.00	\$16.40	\$0.00	\$91.93
	06/01/2026	\$61.83	\$15.00	\$16.40	\$0.00	\$93.23
	12/01/2026	\$63.28	\$15.00	\$16.40	\$0.00	\$94.68
For apprentice rates see "Apprentice- OPERATING ENGINEERS"						
BACKHOE/FRONT-END LOADER <i>OPERATING ENGINEERS LOCAL 4</i>	12/01/2023	\$55.03	\$15.00	\$16.40	\$0.00	\$86.43
	06/01/2024	\$56.33	\$15.00	\$16.40	\$0.00	\$87.73
	12/01/2024	\$57.78	\$15.00	\$16.40	\$0.00	\$89.18
	06/01/2025	\$59.08	\$15.00	\$16.40	\$0.00	\$90.48
	12/01/2025	\$60.53	\$15.00	\$16.40	\$0.00	\$91.93
	06/01/2026	\$61.83	\$15.00	\$16.40	\$0.00	\$93.23
	12/01/2026	\$63.28	\$15.00	\$16.40	\$0.00	\$94.68
For apprentice rates see "Apprentice- OPERATING ENGINEERS"						
BARCO-TYPE JUMPING TAMPER <i>LABORERS - ZONE 2</i>	12/01/2023	\$38.11	\$9.65	\$17.14	\$0.00	\$64.90
For apprentice rates see "Apprentice- LABORER"						
BLOCK PAVER, RAMMER / CURB SETTER <i>LABORERS - ZONE 2</i>	12/01/2023	\$38.61	\$9.65	\$17.14	\$0.00	\$65.40
For apprentice rates see "Apprentice- LABORER"						
BLOCK PAVER, RAMMER / CURB SETTER (HEAVY & HIGHWAY) <i>LABORERS - ZONE 2 (HEAVY & HIGHWAY)</i>	12/01/2023	\$38.61	\$9.65	\$17.14	\$0.00	\$65.40
	06/01/2024	\$39.94	\$9.65	\$17.14	\$0.00	\$66.73
	12/01/2024	\$41.27	\$9.65	\$17.14	\$0.00	\$68.06
	06/01/2025	\$42.66	\$9.65	\$17.14	\$0.00	\$69.45
	12/01/2025	\$44.04	\$9.65	\$17.14	\$0.00	\$70.83
	06/01/2026	\$45.48	\$9.65	\$17.14	\$0.00	\$72.27
	12/01/2026	\$46.92	\$9.65	\$17.14	\$0.00	\$73.71
For apprentice rates see "Apprentice- LABORER (Heavy and Highway)"						
BOILER MAKER <i>BOILERMAKERS LOCAL 29</i>	01/01/2024	\$48.12	\$7.07	\$20.60	\$0.00	\$75.79

Classification

Effective Date Base Wage Health Pension Supplemental Unemployment Total Rate

Apprentice - BOILERMAKER - Local 29

Effective Date - 01/01/2024

Step	percent	Apprentice Base Wage	Health	Pension	Supplemental Unemployment	Total Rate
1	65	\$31.28	\$7.07	\$13.22	\$0.00	\$51.57
2	65	\$31.28	\$7.07	\$13.22	\$0.00	\$51.57
3	70	\$33.68	\$7.07	\$14.23	\$0.00	\$54.98
4	75	\$36.09	\$7.07	\$15.24	\$0.00	\$58.40
5	80	\$38.50	\$7.07	\$16.25	\$0.00	\$61.82
6	85	\$40.90	\$7.07	\$17.28	\$0.00	\$65.25
7	90	\$43.31	\$7.07	\$18.28	\$0.00	\$68.66
8	95	\$45.71	\$7.07	\$19.32	\$0.00	\$72.10

Notes:

Apprentice to Journeyworker Ratio:1:4

BRICK/STONE/ARTIFICIAL MASONRY (INCL. MASONRY WATERPROOFING)	02/01/2024	\$60.26	\$11.49	\$22.90	\$0.00	\$94.65
BRICKLAYERS LOCAL 3 (LOWELL)	08/01/2024	\$62.36	\$11.49	\$22.90	\$0.00	\$96.75
	02/01/2025	\$63.66	\$11.49	\$22.90	\$0.00	\$98.05
	08/01/2025	\$65.81	\$11.49	\$22.90	\$0.00	\$100.20
	02/01/2026	\$67.16	\$11.49	\$22.90	\$0.00	\$101.55
	08/01/2026	\$69.36	\$11.49	\$22.90	\$0.00	\$103.75
	02/01/2027	\$70.76	\$11.49	\$22.90	\$0.00	\$105.15

Classification

Effective Date Base Wage Health Pension Supplemental Unemployment Total Rate

Apprentice - BRICK/PLASTER/CEMENT MASON - Local 3 Lowell

Effective Date - 02/01/2024

Step	percent	Apprentice Base Wage	Health	Pension	Supplemental Unemployment	Total Rate
1	50	\$30.13	\$11.49	\$22.90	\$0.00	\$64.52
2	60	\$36.16	\$11.49	\$22.90	\$0.00	\$70.55
3	70	\$42.18	\$11.49	\$22.90	\$0.00	\$76.57
4	80	\$48.21	\$11.49	\$22.90	\$0.00	\$82.60
5	90	\$54.23	\$11.49	\$22.90	\$0.00	\$88.62

Effective Date - 08/01/2024

Step	percent	Apprentice Base Wage	Health	Pension	Supplemental Unemployment	Total Rate
1	50	\$31.18	\$11.49	\$22.90	\$0.00	\$65.57
2	60	\$37.42	\$11.49	\$22.90	\$0.00	\$71.81
3	70	\$43.65	\$11.49	\$22.90	\$0.00	\$78.04
4	80	\$49.89	\$11.49	\$22.90	\$0.00	\$84.28
5	90	\$56.12	\$11.49	\$22.90	\$0.00	\$90.51

Notes:

Apprentice to Journeyworker Ratio:1:5

BULLDOZER/GRADER/SCRAPER <i>OPERATING ENGINEERS LOCAL 4</i>	12/01/2023	\$54.43	\$15.00	\$16.40	\$0.00	\$85.83
	06/01/2024	\$55.71	\$15.00	\$16.40	\$0.00	\$87.11
	12/01/2024	\$57.15	\$15.00	\$16.40	\$0.00	\$88.55
	06/01/2025	\$58.43	\$15.00	\$16.40	\$0.00	\$89.83
	12/01/2025	\$59.87	\$15.00	\$16.40	\$0.00	\$91.27
	06/01/2026	\$61.15	\$15.00	\$16.40	\$0.00	\$92.55
	12/01/2026	\$62.59	\$15.00	\$16.40	\$0.00	\$93.99

For apprentice rates see "Apprentice- OPERATING ENGINEERS"

CAISSON & UNDERPINNING BOTTOM MAN <i>LABORERS - FOUNDATION AND MARINE</i>	12/01/2023	\$45.48	\$9.65	\$18.22	\$0.00	\$73.35
	06/01/2024	\$46.96	\$9.65	\$18.22	\$0.00	\$74.83
	12/01/2024	\$48.43	\$9.65	\$18.22	\$0.00	\$76.30
	06/01/2025	\$49.93	\$9.65	\$18.22	\$0.00	\$77.80
	12/01/2025	\$51.43	\$9.65	\$18.22	\$0.00	\$79.30
	06/01/2026	\$52.98	\$9.65	\$18.22	\$0.00	\$80.85
	12/01/2026	\$54.48	\$9.65	\$18.22	\$0.00	\$82.35

For apprentice rates see "Apprentice- LABORER"

CAISSON & UNDERPINNING LABORER <i>LABORERS - FOUNDATION AND MARINE</i>	12/01/2023	\$44.33	\$9.65	\$18.22	\$0.00	\$72.20
	06/01/2024	\$45.81	\$9.65	\$18.22	\$0.00	\$73.68
	12/01/2024	\$47.28	\$9.65	\$18.22	\$0.00	\$75.15
	06/01/2025	\$48.78	\$9.65	\$18.22	\$0.00	\$76.65
	12/01/2025	\$50.28	\$9.65	\$18.22	\$0.00	\$78.15
	06/01/2026	\$51.83	\$9.65	\$18.22	\$0.00	\$79.70
	12/01/2026	\$53.33	\$9.65	\$18.22	\$0.00	\$81.20

For apprentice rates see "Apprentice- LABORER"

Classification	Effective Date	Base Wage	Health	Pension	Supplemental Unemployment	Total Rate
CAISSON & UNDERPINNING TOP MAN <i>LABORERS - FOUNDATION AND MARINE</i>	12/01/2023	\$44.33	\$9.65	\$18.22	\$0.00	\$72.20
	06/01/2024	\$45.81	\$9.65	\$18.22	\$0.00	\$73.68
	12/01/2024	\$47.28	\$9.65	\$18.22	\$0.00	\$75.15
	06/01/2025	\$48.78	\$9.65	\$18.22	\$0.00	\$76.65
	12/01/2025	\$50.28	\$9.65	\$18.22	\$0.00	\$78.15
	06/01/2026	\$51.83	\$9.65	\$18.22	\$0.00	\$79.70
	12/01/2026	\$53.33	\$9.65	\$18.22	\$0.00	\$81.20
For apprentice rates see "Apprentice- LABORER"						
CARBIDE CORE DRILL OPERATOR <i>LABORERS - ZONE 2</i>	12/01/2023	\$38.11	\$9.65	\$17.14	\$0.00	\$64.90
For apprentice rates see "Apprentice- LABORER"						
CARPENTER <i>CARPENTERS -ZONE 2 (Eastern Massachusetts)</i>	09/01/2023	\$45.87	\$9.83	\$19.97	\$0.00	\$75.67
	03/01/2024	\$47.12	\$9.83	\$19.97	\$0.00	\$76.92
	09/01/2024	\$48.37	\$9.83	\$19.97	\$0.00	\$78.17
	03/01/2025	\$49.62	\$9.83	\$19.97	\$0.00	\$79.42
	09/01/2025	\$50.87	\$9.83	\$19.97	\$0.00	\$80.67
	03/01/2026	\$52.12	\$9.83	\$19.97	\$0.00	\$81.92
	09/01/2026	\$53.37	\$9.83	\$19.97	\$0.00	\$83.17
	03/01/2027	\$54.62	\$9.83	\$19.97	\$0.00	\$84.42

Classification

Effective Date Base Wage Health Pension Supplemental Unemployment Total Rate

Apprentice - CARPENTER - Zone 2 Eastern MA

Effective Date - 09/01/2023

Step	percent	Apprentice Base Wage	Health	Pension	Supplemental Unemployment	Total Rate
1	50	\$22.94	\$9.83	\$1.73	\$0.00	\$34.50
2	60	\$27.52	\$9.83	\$1.73	\$0.00	\$39.08
3	70	\$32.11	\$9.83	\$14.78	\$0.00	\$56.72
4	75	\$34.40	\$9.83	\$14.78	\$0.00	\$59.01
5	80	\$36.70	\$9.83	\$16.51	\$0.00	\$63.04
6	80	\$36.70	\$9.83	\$16.51	\$0.00	\$63.04
7	90	\$41.28	\$9.83	\$18.24	\$0.00	\$69.35
8	90	\$41.28	\$9.83	\$18.24	\$0.00	\$69.35

Effective Date - 03/01/2024

Step	percent	Apprentice Base Wage	Health	Pension	Supplemental Unemployment	Total Rate
1	50	\$23.56	\$9.83	\$1.73	\$0.00	\$35.12
2	60	\$28.27	\$9.83	\$1.73	\$0.00	\$39.83
3	70	\$32.98	\$9.83	\$14.78	\$0.00	\$57.59
4	75	\$35.34	\$9.83	\$14.78	\$0.00	\$59.95
5	80	\$37.70	\$9.83	\$16.51	\$0.00	\$64.04
6	80	\$37.70	\$9.83	\$16.51	\$0.00	\$64.04
7	90	\$42.41	\$9.83	\$18.24	\$0.00	\$70.48
8	90	\$42.41	\$9.83	\$18.24	\$0.00	\$70.48

Notes:
 % Indentured After 10/1/17; 45/45/55/55/70/70/80/80
 Step 1&2 \$32.20/ 3&4 \$38.76/ 5&6 \$58.45/ 7&8 \$64.77

Apprentice to Journeyworker Ratio:1:5

CARPENTER WOOD FRAME	10/01/2023	\$25.55	\$7.02	\$4.80	\$0.00	\$37.37
CARPENTERS-ZONE 3 (Wood Frame)	10/01/2024	\$26.65	\$7.02	\$4.80	\$0.00	\$38.47
	10/01/2025	\$27.75	\$7.02	\$4.80	\$0.00	\$39.57
	10/01/2026	\$28.85	\$7.02	\$4.80	\$0.00	\$40.67

All Aspects of New Wood Frame Work

Classification

Effective Date Base Wage Health Pension Supplemental Unemployment Total Rate

Apprentice - CARPENTER (Wood Frame) - Zone 3

Effective Date - 10/01/2023

Step	percent	Apprentice Base Wage	Health	Pension	Supplemental Unemployment	Total Rate
1	60	\$15.33	\$7.02	\$0.00	\$0.00	\$22.35
2	60	\$15.33	\$7.02	\$0.00	\$0.00	\$22.35
3	65	\$16.61	\$7.02	\$1.00	\$0.00	\$24.63
4	70	\$17.89	\$7.02	\$1.00	\$0.00	\$25.91
5	75	\$19.16	\$7.02	\$4.80	\$0.00	\$30.98
6	80	\$20.44	\$7.02	\$4.80	\$0.00	\$32.26
7	85	\$21.72	\$7.02	\$4.80	\$0.00	\$33.54
8	90	\$23.00	\$7.02	\$4.80	\$0.00	\$34.82

Effective Date - 10/01/2024

Step	percent	Apprentice Base Wage	Health	Pension	Supplemental Unemployment	Total Rate
1	60	\$15.99	\$7.02	\$0.00	\$0.00	\$23.01
2	60	\$15.99	\$7.02	\$0.00	\$0.00	\$23.01
3	65	\$17.32	\$7.02	\$1.00	\$0.00	\$25.34
4	70	\$18.66	\$7.02	\$1.00	\$0.00	\$26.68
5	75	\$19.99	\$7.02	\$4.80	\$0.00	\$31.81
6	80	\$21.32	\$7.02	\$4.80	\$0.00	\$33.14
7	85	\$22.65	\$7.02	\$4.80	\$0.00	\$34.47
8	90	\$23.99	\$7.02	\$4.80	\$0.00	\$35.81

Notes:
 % Indentured After 10/1/17; 45/45/55/55/70/70/80/80
 Step 1&2 \$18.52/ 3&4 \$21.07/ 5&6 \$28.70/ 7&8 \$31.26

Apprentice to Journeyworker Ratio:1:5

CEMENT MASONRY/PLASTERING BRICKLAYERS LOCAL 3 (LOWELL)	01/01/2024	\$49.33	\$13.00	\$23.57	\$1.30	\$87.20
---	------------	---------	---------	---------	--------	---------

Apprentice - CEMENT MASONRY/PLASTERING - Lowell

Effective Date - 01/01/2024

Step	percent	Apprentice Base Wage	Health	Pension	Supplemental Unemployment	Total Rate
1	50	\$24.67	\$13.00	\$15.93	\$0.00	\$53.60
2	60	\$29.60	\$13.00	\$18.57	\$1.30	\$62.47
3	65	\$32.06	\$13.00	\$19.57	\$1.30	\$65.93
4	70	\$34.53	\$13.00	\$20.57	\$1.30	\$69.40
5	75	\$37.00	\$13.00	\$21.57	\$1.30	\$72.87
6	80	\$39.46	\$13.00	\$22.57	\$1.30	\$76.33
7	90	\$44.40	\$13.00	\$23.57	\$1.30	\$82.27

Notes:
 Steps 3,4 are 500 hrs. All other steps are 1,000 hrs.

Apprentice to Journeyworker Ratio:1:3

Classification	Effective Date	Base Wage	Health	Pension	Supplemental Unemployment	Total Rate
CHAIN SAW OPERATOR <i>LABORERS - ZONE 2</i>	12/01/2023	\$38.11	\$9.65	\$17.14	\$0.00	\$64.90
For apprentice rates see "Apprentice- LABORER"						
CLAM SHELLS/SLURRY BUCKETS/HEADING MACHINES <i>OPERATING ENGINEERS LOCAL 4</i>	12/01/2023	\$56.13	\$15.00	\$16.40	\$0.00	\$87.53
	06/01/2024	\$57.45	\$15.00	\$16.40	\$0.00	\$88.85
	12/01/2024	\$58.93	\$15.00	\$16.40	\$0.00	\$90.33
	06/01/2025	\$60.26	\$15.00	\$16.40	\$0.00	\$91.66
	12/01/2025	\$61.73	\$15.00	\$16.40	\$0.00	\$93.13
	06/01/2026	\$63.06	\$15.00	\$16.40	\$0.00	\$94.46
	12/01/2026	\$64.54	\$15.00	\$16.40	\$0.00	\$95.94
For apprentice rates see "Apprentice- OPERATING ENGINEERS"						
COMPRESSOR OPERATOR <i>OPERATING ENGINEERS LOCAL 4</i>	12/01/2023	\$35.62	\$15.00	\$16.40	\$0.00	\$67.02
	06/01/2024	\$36.47	\$15.00	\$16.40	\$0.00	\$67.87
	12/01/2024	\$37.42	\$15.00	\$16.40	\$0.00	\$68.82
	06/01/2025	\$38.27	\$15.00	\$16.40	\$0.00	\$69.67
	12/01/2025	\$39.22	\$15.00	\$16.40	\$0.00	\$70.62
	06/01/2026	\$40.08	\$15.00	\$16.40	\$0.00	\$71.48
	12/01/2026	\$41.03	\$15.00	\$16.40	\$0.00	\$72.43
For apprentice rates see "Apprentice- OPERATING ENGINEERS"						
DELEADER (BRIDGE) <i>PAINTERS LOCAL 35 - ZONE 2</i>	01/01/2024	\$56.06	\$9.95	\$23.95	\$0.00	\$89.96
	07/01/2024	\$57.26	\$9.95	\$23.95	\$0.00	\$91.16
	01/01/2025	\$58.46	\$9.95	\$23.95	\$0.00	\$92.36

Classification

Effective Date Base Wage Health Pension Supplemental Unemployment Total Rate

Apprentice - PAINTER Local 35 - BRIDGES/TANKS

Effective Date - 01/01/2024

Step	percent	Apprentice Base Wage	Health	Pension	Supplemental Unemployment	Total Rate
1	50	\$28.03	\$9.95	\$0.00	\$0.00	\$37.98
2	55	\$30.83	\$9.95	\$6.66	\$0.00	\$47.44
3	60	\$33.64	\$9.95	\$7.26	\$0.00	\$50.85
4	65	\$36.44	\$9.95	\$7.87	\$0.00	\$54.26
5	70	\$39.24	\$9.95	\$20.32	\$0.00	\$69.51
6	75	\$42.05	\$9.95	\$20.93	\$0.00	\$72.93
7	80	\$44.85	\$9.95	\$21.53	\$0.00	\$76.33
8	90	\$50.45	\$9.95	\$22.74	\$0.00	\$83.14

Effective Date - 07/01/2024

Step	percent	Apprentice Base Wage	Health	Pension	Supplemental Unemployment	Total Rate
1	50	\$28.63	\$9.95	\$0.00	\$0.00	\$38.58
2	55	\$31.49	\$9.95	\$6.66	\$0.00	\$48.10
3	60	\$34.36	\$9.95	\$7.26	\$0.00	\$51.57
4	65	\$37.22	\$9.95	\$7.87	\$0.00	\$55.04
5	70	\$40.08	\$9.95	\$20.32	\$0.00	\$70.35
6	75	\$42.95	\$9.95	\$20.93	\$0.00	\$73.83
7	80	\$45.81	\$9.95	\$21.53	\$0.00	\$77.29
8	90	\$51.53	\$9.95	\$22.74	\$0.00	\$84.22

Notes:
Steps are 750 hrs.

Apprentice to Journeyworker Ratio:1:1

DEMO: ADZEMAN LABORERS - ZONE 2	12/01/2023	\$44.48	\$9.65	\$18.07	\$0.00	\$72.20
------------------------------------	------------	---------	--------	---------	--------	---------

For apprentice rates see "Apprentice- LABORER"

DEMO: BACKHOE/LOADER/HAMMER OPERATOR LABORERS - ZONE 2	12/01/2023	\$45.48	\$9.65	\$18.07	\$0.00	\$73.20
---	------------	---------	--------	---------	--------	---------

For apprentice rates see "Apprentice- LABORER"

DEMO: BURNERS LABORERS - ZONE 2	12/01/2023	\$45.23	\$9.65	\$18.07	\$0.00	\$72.95
------------------------------------	------------	---------	--------	---------	--------	---------

For apprentice rates see "Apprentice- LABORER"

DEMO: CONCRETE CUTTER/SAWYER LABORERS - ZONE 2	12/01/2023	\$45.48	\$9.65	\$18.07	\$0.00	\$73.20
---	------------	---------	--------	---------	--------	---------

For apprentice rates see "Apprentice- LABORER"

DEMO: JACKHAMMER OPERATOR LABORERS - ZONE 2	12/01/2023	\$45.23	\$9.65	\$18.07	\$0.00	\$72.95
--	------------	---------	--------	---------	--------	---------

For apprentice rates see "Apprentice- LABORER"

DEMO: WRECKING LABORER LABORERS - ZONE 2	12/01/2023	\$44.48	\$9.65	\$18.07	\$0.00	\$72.20
---	------------	---------	--------	---------	--------	---------

For apprentice rates see "Apprentice- LABORER"

Classification	Effective Date	Base Wage	Health	Pension	Supplemental Unemployment	Total Rate
DIRECTIONAL DRILL MACHINE OPERATOR <i>OPERATING ENGINEERS LOCAL 4</i>	12/01/2023	\$54.43	\$15.00	\$16.40	\$0.00	\$85.83
	06/01/2024	\$55.71	\$15.00	\$16.40	\$0.00	\$87.11
	12/01/2024	\$57.15	\$15.00	\$16.40	\$0.00	\$88.55
	06/01/2025	\$58.43	\$15.00	\$16.40	\$0.00	\$89.83
	12/01/2025	\$59.87	\$15.00	\$16.40	\$0.00	\$91.27
	06/01/2026	\$61.15	\$15.00	\$16.40	\$0.00	\$92.55
	12/01/2026	\$62.59	\$15.00	\$16.40	\$0.00	\$93.99
For apprentice rates see "Apprentice- OPERATING ENGINEERS"						
DIVER <i>PILE DRIVER LOCAL 56 (ZONE 1)</i>	08/01/2020	\$68.70	\$9.40	\$23.12	\$0.00	\$101.22
For apprentice rates see "Apprentice- PILE DRIVER"						
DIVER TENDER <i>PILE DRIVER LOCAL 56 (ZONE 1)</i>	08/01/2020	\$49.07	\$9.40	\$23.12	\$0.00	\$81.59
For apprentice rates see "Apprentice- PILE DRIVER"						
DIVER TENDER (EFFLUENT) <i>PILE DRIVER LOCAL 56 (ZONE 1)</i>	08/01/2020	\$73.60	\$9.40	\$23.12	\$0.00	\$106.12
For apprentice rates see "Apprentice- PILE DRIVER"						
DIVER/SLURRY (EFFLUENT) <i>PILE DRIVER LOCAL 56 (ZONE 1)</i>	08/01/2020	\$103.05	\$9.40	\$23.12	\$0.00	\$135.57
For apprentice rates see "Apprentice- PILE DRIVER"						
DRAWBRIDGE OPERATOR (Construction) <i>DRAWBRIDGE - SEIU LOCAL 888</i>	07/01/2020	\$26.77	\$6.67	\$3.93	\$0.16	\$37.53
ELECTRICIAN <i>ELECTRICIANS LOCAL 96</i>	09/03/2023	\$45.99	\$13.00	\$18.84	\$0.00	\$77.83
	09/01/2024	\$47.05	\$13.99	\$19.22	\$0.00	\$80.26
	09/07/2025	\$48.16	\$14.98	\$19.60	\$0.00	\$82.74
	09/06/2026	\$49.38	\$15.96	\$20.00	\$0.00	\$85.34

Classification

Effective Date Base Wage Health Pension Supplemental Unemployment Total Rate

Apprentice - ELECTRICIAN - Local 96

Effective Date - 09/03/2023

Step	percent	Apprentice Base Wage	Health	Pension	Supplemental Unemployment	Total Rate
1	40	\$18.40	\$13.00	\$0.55	\$0.00	\$31.95
2	45	\$20.70	\$13.00	\$0.62	\$0.00	\$34.32
3	48	\$22.08	\$13.00	\$15.49	\$0.00	\$50.57
4	55	\$25.29	\$13.00	\$15.94	\$0.00	\$54.23
5	65	\$29.89	\$13.00	\$16.59	\$0.00	\$59.48
6	80	\$36.79	\$13.00	\$17.55	\$0.00	\$67.34

Effective Date - 09/01/2024

Step	percent	Apprentice Base Wage	Health	Pension	Supplemental Unemployment	Total Rate
1	40	\$18.82	\$13.99	\$0.56	\$0.00	\$33.37
2	45	\$21.17	\$13.99	\$0.64	\$0.00	\$35.80
3	48	\$22.58	\$13.99	\$15.79	\$0.00	\$52.36
4	55	\$25.88	\$13.99	\$16.26	\$0.00	\$56.13
5	65	\$30.58	\$13.99	\$16.91	\$0.00	\$61.48
6	80	\$37.64	\$13.99	\$17.90	\$0.00	\$69.53

Notes:

Steps 1-2 are 1000 hrs; Steps 3-6 are 1500 hrs.

Apprentice to Journeyworker Ratio:2:3***

ELEVATOR CONSTRUCTOR	01/01/2024	\$61.98	\$16.18	\$20.96	\$0.00	\$99.12
ELEVATOR CONSTRUCTORS LOCAL 41	01/01/2025	\$62.83	\$16.28	\$21.36	\$0.00	\$100.47
	01/01/2026	\$63.68	\$16.38	\$21.76	\$0.00	\$101.82
	01/01/2027	\$64.53	\$16.48	\$22.16	\$0.00	\$103.17

Classification

Effective Date Base Wage Health Pension Supplemental Unemployment Total Rate

Apprentice - ELEVATOR CONSTRUCTOR - Local 41

Effective Date - 01/01/2024

Step	percent	Apprentice Base Wage	Health	Pension	Supplemental Unemployment	Total Rate
1	50	\$30.99	\$16.18	\$0.00	\$0.00	\$47.17
2	55	\$34.09	\$16.18	\$20.96	\$0.00	\$71.23
3	65	\$40.29	\$16.18	\$20.96	\$0.00	\$77.43
4	70	\$43.39	\$16.18	\$20.96	\$0.00	\$80.53
5	80	\$49.58	\$16.18	\$20.96	\$0.00	\$86.72

Effective Date - 01/01/2025

Step	percent	Apprentice Base Wage	Health	Pension	Supplemental Unemployment	Total Rate
1	50	\$31.42	\$16.28	\$0.00	\$0.00	\$47.70
2	55	\$34.56	\$16.28	\$21.36	\$0.00	\$72.20
3	65	\$40.84	\$16.28	\$21.36	\$0.00	\$78.48
4	70	\$43.98	\$16.28	\$21.36	\$0.00	\$81.62
5	80	\$50.26	\$16.28	\$21.36	\$0.00	\$87.90

Notes:

Steps 1-2 are 6 mos.; Steps 3-5 are 1 year

Apprentice to Journeyworker Ratio:1:1

ELEVATOR CONSTRUCTOR HELPER	01/01/2024	\$43.39	\$16.18	\$20.96	\$0.00	\$80.53
<i>ELEVATOR CONSTRUCTORS LOCAL 41</i>	01/01/2025	\$43.98	\$16.28	\$21.36	\$0.00	\$81.62
	01/01/2026	\$44.58	\$16.38	\$21.76	\$0.00	\$82.72
	01/01/2027	\$45.17	\$16.48	\$22.16	\$0.00	\$83.81

For apprentice rates see "Apprentice - ELEVATOR CONSTRUCTOR"

FENCE & GUARD RAIL ERECTOR (HEAVY & HIGHWAY)	12/01/2023	\$38.11	\$9.65	\$17.14	\$0.00	\$64.90
<i>LABORERS - ZONE 2 (HEAVY & HIGHWAY)</i>	06/01/2024	\$39.44	\$9.65	\$17.14	\$0.00	\$66.23
	12/01/2024	\$40.77	\$9.65	\$17.14	\$0.00	\$67.56
	06/01/2025	\$42.16	\$9.65	\$17.14	\$0.00	\$68.95
	12/01/2025	\$43.54	\$9.65	\$17.14	\$0.00	\$70.33
	06/01/2026	\$44.98	\$9.65	\$17.14	\$0.00	\$71.77
	12/01/2026	\$46.42	\$9.65	\$17.14	\$0.00	\$73.21

For apprentice rates see "Apprentice- LABORER (Heavy and Highway)"

FIELD ENG.INST.PERSON-BLDG,SITE,HVY/HWY	11/01/2023	\$50.30	\$14.50	\$16.15	\$0.00	\$80.95
<i>OPERATING ENGINEERS LOCAL 4</i>	05/01/2024	\$51.54	\$14.50	\$16.15	\$0.00	\$82.19
	11/01/2024	\$52.83	\$14.50	\$16.15	\$0.00	\$83.48
	05/01/2025	\$54.27	\$14.50	\$16.15	\$0.00	\$84.92
	11/01/2025	\$55.56	\$14.50	\$16.15	\$0.00	\$86.21
	05/01/2026	\$57.00	\$14.50	\$16.15	\$0.00	\$87.65
	11/01/2026	\$58.29	\$14.50	\$16.15	\$0.00	\$88.94
	05/01/2027	\$59.72	\$14.50	\$16.15	\$0.00	\$90.37

For apprentice rates see "Apprentice- OPERATING ENGINEERS"

Classification	Effective Date	Base Wage	Health	Pension	Supplemental Unemployment	Total Rate
FIELD ENG.PARTY CHIEF-BLDG,SITE,HVY/HWY <i>OPERATING ENGINEERS LOCAL 4</i>	11/01/2023	\$51.87	\$14.50	\$16.15	\$0.00	\$82.52
	05/01/2024	\$53.12	\$14.50	\$16.15	\$0.00	\$83.77
	11/01/2024	\$54.42	\$14.50	\$16.15	\$0.00	\$85.07
	05/01/2025	\$55.87	\$14.50	\$16.15	\$0.00	\$86.52
	11/01/2025	\$57.17	\$14.50	\$16.15	\$0.00	\$87.82
	05/01/2026	\$58.62	\$14.50	\$16.15	\$0.00	\$89.27
	11/01/2026	\$59.92	\$14.50	\$16.15	\$0.00	\$90.57
	05/01/2027	\$61.37	\$14.50	\$16.15	\$0.00	\$92.02
For apprentice rates see "Apprentice- OPERATING ENGINEERS"						
FIELD ENG.ROD PERSON-BLDG,SITE,HVY/HWY <i>OPERATING ENGINEERS LOCAL 4</i>	11/01/2023	\$24.93	\$14.50	\$16.15	\$0.00	\$55.58
	05/01/2024	\$25.66	\$14.50	\$16.15	\$0.00	\$56.31
	11/01/2024	\$26.42	\$14.50	\$16.15	\$0.00	\$57.07
	05/01/2025	\$27.27	\$14.50	\$16.15	\$0.00	\$57.92
	11/01/2025	\$28.03	\$14.50	\$16.15	\$0.00	\$58.68
	05/01/2026	\$28.88	\$14.50	\$16.15	\$0.00	\$59.53
	11/01/2026	\$29.64	\$14.50	\$16.15	\$0.00	\$60.29
	05/01/2027	\$30.49	\$14.50	\$16.15	\$0.00	\$61.14
For apprentice rates see "Apprentice- OPERATING ENGINEERS"						
FIRE ALARM INSTALLER <i>ELECTRICIANS LOCAL 96</i>	09/03/2023	\$45.99	\$13.00	\$18.84	\$0.00	\$77.83
	09/01/2024	\$47.05	\$13.99	\$19.22	\$0.00	\$80.26
	09/07/2025	\$48.16	\$14.98	\$19.60	\$0.00	\$82.74
	09/06/2026	\$49.38	\$15.96	\$20.00	\$0.00	\$85.34
For apprentice rates see "Apprentice- ELECTRICIAN"						
FIRE ALARM REPAIR / MAINT/COMMISSIONING <i>ELECTRICIANS LOCAL 96</i>	09/03/2023	\$45.99	\$13.00	\$18.84	\$0.00	\$77.83
	09/01/2024	\$47.05	\$13.99	\$19.22	\$0.00	\$80.26
	09/07/2025	\$48.16	\$14.98	\$19.60	\$0.00	\$82.74
	09/06/2026	\$49.38	\$15.96	\$20.00	\$0.00	\$85.34
For apprentice rates see "Apprentice- ELECTRICIAN"						
FIREMAN (ASST. ENGINEER) <i>OPERATING ENGINEERS LOCAL 4</i>	12/01/2023	\$44.47	\$15.00	\$16.40	\$0.00	\$75.87
	06/01/2024	\$45.53	\$15.00	\$16.40	\$0.00	\$76.93
	12/01/2024	\$46.71	\$15.00	\$16.40	\$0.00	\$78.11
	06/01/2025	\$47.77	\$15.00	\$16.40	\$0.00	\$79.17
	12/01/2025	\$48.94	\$15.00	\$16.40	\$0.00	\$80.34
	06/01/2026	\$50.00	\$15.00	\$16.40	\$0.00	\$81.40
	12/01/2026	\$51.18	\$15.00	\$16.40	\$0.00	\$82.58
For apprentice rates see "Apprentice- OPERATING ENGINEERS"						
FLAGGER & SIGNALER (HEAVY & HIGHWAY) <i>LABORERS - ZONE 2 (HEAVY & HIGHWAY)</i>	12/01/2023	\$25.48	\$9.65	\$17.14	\$0.00	\$52.27
	06/01/2024	\$26.51	\$9.65	\$17.14	\$0.00	\$53.30
	12/01/2024	\$26.51	\$9.65	\$17.14	\$0.00	\$53.30
	06/01/2025	\$27.59	\$9.65	\$17.14	\$0.00	\$54.38
	12/01/2025	\$27.59	\$9.65	\$17.14	\$0.00	\$54.38
	06/01/2026	\$28.71	\$9.65	\$17.14	\$0.00	\$55.50
	12/01/2026	\$28.71	\$9.65	\$17.14	\$0.00	\$55.50
For apprentice rates see "Apprentice- LABORER (Heavy and Highway)"						

Classification	Effective Date	Base Wage	Health	Pension	Supplemental Unemployment	Total Rate
FLOORCOVERER FLOORCOVERERS LOCAL 2168 ZONE I	09/01/2023	\$53.48	\$8.83	\$20.27	\$0.00	\$82.58
	03/01/2024	\$54.73	\$8.83	\$20.27	\$0.00	\$83.83
	09/01/2024	\$56.23	\$8.83	\$20.27	\$0.00	\$85.33
	03/01/2025	\$57.73	\$8.83	\$20.27	\$0.00	\$86.83
	09/01/2025	\$59.23	\$8.83	\$20.27	\$0.00	\$88.33
	03/01/2026	\$60.73	\$8.83	\$20.27	\$0.00	\$89.83
	09/01/2026	\$62.23	\$8.83	\$20.27	\$0.00	\$91.33
	03/01/2027	\$63.73	\$8.83	\$20.27	\$0.00	\$92.83

Apprentice - FLOORCOVERER - Local 2168 Zone I

Effective Date - 09/01/2023

Step	percent	Apprentice Base Wage	Health	Pension	Supplemental Unemployment	Total Rate
1	50	\$26.74	\$8.83	\$1.76	\$0.00	\$37.33
2	55	\$29.41	\$8.83	\$1.76	\$0.00	\$40.00
3	60	\$32.09	\$8.83	\$3.52	\$0.00	\$44.44
4	65	\$34.76	\$8.83	\$3.52	\$0.00	\$47.11
5	70	\$37.44	\$8.83	\$16.75	\$0.00	\$63.02
6	75	\$40.11	\$8.83	\$16.75	\$0.00	\$65.69
7	80	\$42.78	\$8.83	\$18.51	\$0.00	\$70.12
8	85	\$45.46	\$8.83	\$18.51	\$0.00	\$72.80

Effective Date - 03/01/2024

Step	percent	Apprentice Base Wage	Health	Pension	Supplemental Unemployment	Total Rate
1	50	\$27.37	\$8.83	\$1.76	\$0.00	\$37.96
2	55	\$30.10	\$8.83	\$1.76	\$0.00	\$40.69
3	60	\$32.84	\$8.83	\$3.52	\$0.00	\$45.19
4	65	\$35.57	\$8.83	\$3.52	\$0.00	\$47.92
5	70	\$38.31	\$8.83	\$16.75	\$0.00	\$63.89
6	75	\$41.05	\$8.83	\$16.75	\$0.00	\$66.63
7	80	\$43.78	\$8.83	\$18.51	\$0.00	\$71.12
8	85	\$46.52	\$8.83	\$18.51	\$0.00	\$73.86

Notes: Steps are 750 hrs.
 % After 10/1/17; 45/45/55/55/70/70/80/80 (1500hr Steps)
 Step 1&2 \$34.65/ 3&4 \$41.76/ 5&6 \$63.02/ 7&8 \$70.12

Apprentice to Journeyworker Ratio:1:1

FORK LIFT/CHERRY PICKER OPERATING ENGINEERS LOCAL 4	12/01/2023	\$55.03	\$15.00	\$16.40	\$0.00	\$86.43
	06/01/2024	\$56.33	\$15.00	\$16.40	\$0.00	\$87.73
	12/01/2024	\$57.78	\$15.00	\$16.40	\$0.00	\$89.18
	06/01/2025	\$59.08	\$15.00	\$16.40	\$0.00	\$90.48
	12/01/2025	\$60.53	\$15.00	\$16.40	\$0.00	\$91.93
	06/01/2026	\$61.83	\$15.00	\$16.40	\$0.00	\$93.23
	12/01/2026	\$63.28	\$15.00	\$16.40	\$0.00	\$94.68

For apprentice rates see "Apprentice- OPERATING ENGINEERS"

Classification	Effective Date	Base Wage	Health	Pension	Supplemental Unemployment	Total Rate
GENERATOR/LIGHTING PLANT/HEATERS <i>OPERATING ENGINEERS LOCAL 4</i>	12/01/2023	\$35.62	\$15.00	\$16.40	\$0.00	\$67.02
	06/01/2024	\$36.47	\$15.00	\$16.40	\$0.00	\$67.87
	12/01/2024	\$37.42	\$15.00	\$16.40	\$0.00	\$68.82
	06/01/2025	\$38.27	\$15.00	\$16.40	\$0.00	\$69.67
	12/01/2025	\$39.22	\$15.00	\$16.40	\$0.00	\$70.62
	06/01/2026	\$40.08	\$15.00	\$16.40	\$0.00	\$71.48
	12/01/2026	\$41.03	\$15.00	\$16.40	\$0.00	\$72.43

For apprentice rates see "Apprentice- OPERATING ENGINEERS"

GLAZIER (GLASS PLANK/AIR BARRIER/INTERIOR SYSTEMS) <i>GLAZIERS LOCAL 35 (ZONE 2)</i>	01/01/2024	\$45.56	\$9.95	\$23.95	\$0.00	\$79.46
	07/01/2024	\$46.76	\$9.95	\$23.95	\$0.00	\$80.66
	01/01/2025	\$47.96	\$9.95	\$23.95	\$0.00	\$81.86

Apprentice - GLAZIER - Local 35 Zone 2

Effective Date - 01/01/2024

Step	percent	Apprentice Base Wage	Health	Pension	Supplemental Unemployment	Total Rate
1	50	\$22.78	\$9.95	\$0.00	\$0.00	\$32.73
2	55	\$25.06	\$9.95	\$6.66	\$0.00	\$41.67
3	60	\$27.34	\$9.95	\$7.26	\$0.00	\$44.55
4	65	\$29.61	\$9.95	\$7.87	\$0.00	\$47.43
5	70	\$31.89	\$9.95	\$20.32	\$0.00	\$62.16
6	75	\$34.17	\$9.95	\$20.93	\$0.00	\$65.05
7	80	\$36.45	\$9.95	\$21.53	\$0.00	\$67.93
8	90	\$41.00	\$9.95	\$22.74	\$0.00	\$73.69

Effective Date - 07/01/2024

Step	percent	Apprentice Base Wage	Health	Pension	Supplemental Unemployment	Total Rate
1	50	\$23.38	\$9.95	\$0.00	\$0.00	\$33.33
2	55	\$25.72	\$9.95	\$6.66	\$0.00	\$42.33
3	60	\$28.06	\$9.95	\$7.26	\$0.00	\$45.27
4	65	\$30.39	\$9.95	\$7.87	\$0.00	\$48.21
5	70	\$32.73	\$9.95	\$20.32	\$0.00	\$63.00
6	75	\$35.07	\$9.95	\$20.93	\$0.00	\$65.95
7	80	\$37.41	\$9.95	\$21.53	\$0.00	\$68.89
8	90	\$42.08	\$9.95	\$22.74	\$0.00	\$74.77

Notes:

Steps are 750 hrs.

Apprentice to Journeyworker Ratio:1:1

HOISTING ENGINEER/CRANES/GRADALLS <i>OPERATING ENGINEERS LOCAL 4</i>	12/01/2023	\$55.03	\$15.00	\$16.40	\$0.00	\$86.43
	06/01/2024	\$56.33	\$15.00	\$16.40	\$0.00	\$87.73
	12/01/2024	\$57.78	\$15.00	\$16.40	\$0.00	\$89.18
	06/01/2025	\$59.08	\$15.00	\$16.40	\$0.00	\$90.48
	12/01/2025	\$60.53	\$15.00	\$16.40	\$0.00	\$91.93
	06/01/2026	\$61.83	\$15.00	\$16.40	\$0.00	\$93.23
	12/01/2026	\$63.28	\$15.00	\$16.40	\$0.00	\$94.68

Classification

Effective Date Base Wage Health Pension Supplemental Unemployment Total Rate

Apprentice - OPERATING ENGINEERS - Local 4

Effective Date - 12/01/2023

Step	percent	Apprentice Base Wage	Health	Pension	Supplemental Unemployment	Total Rate
1	55	\$30.27	\$15.00	\$0.00	\$0.00	\$45.27
2	60	\$33.02	\$15.00	\$16.40	\$0.00	\$64.42
3	65	\$35.77	\$15.00	\$16.40	\$0.00	\$67.17
4	70	\$38.52	\$15.00	\$16.40	\$0.00	\$69.92
5	75	\$41.27	\$15.00	\$16.40	\$0.00	\$72.67
6	80	\$44.02	\$15.00	\$16.40	\$0.00	\$75.42
7	85	\$46.78	\$15.00	\$16.40	\$0.00	\$78.18
8	90	\$49.53	\$15.00	\$16.40	\$0.00	\$80.93

Effective Date - 06/01/2024

Step	percent	Apprentice Base Wage	Health	Pension	Supplemental Unemployment	Total Rate
1	55	\$30.98	\$15.00	\$0.00	\$0.00	\$45.98
2	60	\$33.80	\$15.00	\$16.40	\$0.00	\$65.20
3	65	\$36.61	\$15.00	\$16.40	\$0.00	\$68.01
4	70	\$39.43	\$15.00	\$16.40	\$0.00	\$70.83
5	75	\$42.25	\$15.00	\$16.40	\$0.00	\$73.65
6	80	\$45.06	\$15.00	\$16.40	\$0.00	\$76.46
7	85	\$47.88	\$15.00	\$16.40	\$0.00	\$79.28
8	90	\$50.70	\$15.00	\$16.40	\$0.00	\$82.10

Notes:

Apprentice to Journeyworker Ratio:1:6

HVAC (DUCTWORK) SHEETMETAL WORKERS LOCAL 17 - A	02/01/2024	\$57.22	\$14.59	\$27.50	\$2.98	\$102.29
	08/01/2024	\$58.97	\$14.59	\$27.50	\$2.98	\$104.04
	02/01/2025	\$60.72	\$14.59	\$27.50	\$2.98	\$105.79
	08/01/2025	\$62.57	\$14.59	\$27.50	\$2.98	\$107.64
	02/01/2026	\$64.52	\$14.59	\$27.50	\$2.98	\$109.59

For apprentice rates see "Apprentice- SHEET METAL WORKER"

HVAC (ELECTRICAL CONTROLS) ELECTRICIANS LOCAL 96	09/03/2023	\$45.99	\$13.00	\$18.84	\$0.00	\$77.83
	09/01/2024	\$47.05	\$13.99	\$19.22	\$0.00	\$80.26
	09/07/2025	\$48.16	\$14.98	\$19.60	\$0.00	\$82.74
	09/06/2026	\$49.38	\$15.96	\$20.00	\$0.00	\$85.34

For apprentice rates see "Apprentice- ELECTRICIAN"

HVAC (TESTING AND BALANCING - AIR) SHEETMETAL WORKERS LOCAL 17 - A	02/01/2024	\$57.22	\$14.59	\$27.50	\$2.98	\$102.29
	08/01/2024	\$58.97	\$14.59	\$27.50	\$2.98	\$104.04
	02/01/2025	\$60.72	\$14.59	\$27.50	\$2.98	\$105.79
	08/01/2025	\$62.57	\$14.59	\$27.50	\$2.98	\$107.64
	02/01/2026	\$64.52	\$14.59	\$27.50	\$2.98	\$109.59

For apprentice rates see "Apprentice- SHEET METAL WORKER"

Classification	Effective Date	Base Wage	Health	Pension	Supplemental Unemployment	Total Rate
HVAC (TESTING AND BALANCING -WATER) <i>PIPEFITTERS LOCAL 537</i>	09/01/2023	\$63.48	\$12.70	\$21.80	\$0.00	\$97.98
	03/01/2024	\$65.28	\$12.70	\$21.80	\$0.00	\$99.78
	09/01/2024	\$67.08	\$12.70	\$21.80	\$0.00	\$101.58
	03/01/2025	\$68.88	\$12.70	\$21.80	\$0.00	\$103.38
For apprentice rates see "Apprentice- PIPEFITTER" or "PLUMBER/PIPEFITTER"						
HVAC MECHANIC <i>PIPEFITTERS LOCAL 537</i>	09/01/2023	\$63.48	\$12.70	\$21.80	\$0.00	\$97.98
	03/01/2024	\$65.28	\$12.70	\$21.80	\$0.00	\$99.78
	09/01/2024	\$67.08	\$12.70	\$21.80	\$0.00	\$101.58
	03/01/2025	\$68.88	\$12.70	\$21.80	\$0.00	\$103.38
For apprentice rates see "Apprentice- PIPEFITTER" or "PLUMBER/PIPEFITTER"						
HYDRAULIC DRILLS <i>LABORERS - ZONE 2</i>	12/01/2023	\$38.61	\$9.65	\$17.14	\$0.00	\$65.40
For apprentice rates see "Apprentice- LABORER"						
HYDRAULIC DRILLS (HEAVY & HIGHWAY) <i>LABORERS - ZONE 2 (HEAVY & HIGHWAY)</i>	12/01/2023	\$38.61	\$9.65	\$17.14	\$0.00	\$65.40
	06/01/2024	\$39.94	\$9.65	\$17.14	\$0.00	\$66.73
	12/01/2024	\$41.27	\$9.65	\$17.14	\$0.00	\$68.06
	06/01/2025	\$42.66	\$9.65	\$17.14	\$0.00	\$69.45
	12/01/2025	\$44.04	\$9.65	\$17.14	\$0.00	\$70.83
	06/01/2026	\$45.48	\$9.65	\$17.14	\$0.00	\$72.27
	12/01/2026	\$46.92	\$9.65	\$17.14	\$0.00	\$73.71
For apprentice rates see "Apprentice- LABORER (Heavy and Highway)"						
INSULATOR (PIPES & TANKS) <i>HEAT & FROST INSULATORS LOCAL 6 (BOSTON)</i>	09/01/2023	\$53.50	\$14.75	\$19.61	\$0.00	\$87.86
	09/01/2024	\$56.92	\$14.75	\$19.61	\$0.00	\$91.28
	09/01/2025	\$60.34	\$14.75	\$19.61	\$0.00	\$94.70
	09/01/2026	\$63.76	\$14.75	\$19.61	\$0.00	\$98.12

Apprentice - ASBESTOS INSULATOR (Pipes & Tanks) - Local 6 Boston

Effective Date - 09/01/2023

Step	percent	Apprentice Base Wage	Health	Pension	Supplemental Unemployment	Total Rate
1	50	\$26.75	\$14.75	\$14.32	\$0.00	\$55.82
2	60	\$32.10	\$14.75	\$15.37	\$0.00	\$62.22
3	70	\$37.45	\$14.75	\$16.43	\$0.00	\$68.63
4	80	\$42.80	\$14.75	\$17.49	\$0.00	\$75.04

Effective Date - 09/01/2024

Step	percent	Apprentice Base Wage	Health	Pension	Supplemental Unemployment	Total Rate
1	50	\$28.46	\$14.75	\$14.32	\$0.00	\$57.53
2	60	\$34.15	\$14.75	\$15.37	\$0.00	\$64.27
3	70	\$39.84	\$14.75	\$16.43	\$0.00	\$71.02
4	80	\$45.54	\$14.75	\$17.49	\$0.00	\$77.78

Notes:

Steps are 1 year

Apprentice to Journeyworker Ratio:1:4

IRONWORKER/WELDER <i>IRONWORKERS LOCAL 7 (WORCESTER AREA)</i>	03/16/2023	\$52.42	\$8.35	\$26.70	\$0.00	\$87.47
	03/16/2024	\$53.67	\$8.35	\$26.70	\$0.00	\$88.72

Classification

Effective Date Base Wage Health Pension Supplemental Unemployment Total Rate

Apprentice - IRONWORKER - Local 7 Worcester

Effective Date - 03/16/2023

Step	percent	Apprentice Base Wage	Health	Pension	Supplemental Unemployment	Total Rate
1	60	\$31.45	\$8.35	\$26.70	\$0.00	\$66.50
2	70	\$36.69	\$8.35	\$26.70	\$0.00	\$71.74
3	75	\$39.32	\$8.35	\$26.70	\$0.00	\$74.37
4	80	\$41.94	\$8.35	\$26.70	\$0.00	\$76.99
5	85	\$44.56	\$8.35	\$26.70	\$0.00	\$79.61
6	90	\$47.18	\$8.35	\$26.70	\$0.00	\$82.23

Effective Date - 03/16/2024

Step	percent	Apprentice Base Wage	Health	Pension	Supplemental Unemployment	Total Rate
1	60	\$32.20	\$8.35	\$26.70	\$0.00	\$67.25
2	70	\$37.57	\$8.35	\$26.70	\$0.00	\$72.62
3	75	\$40.25	\$8.35	\$26.70	\$0.00	\$75.30
4	80	\$42.94	\$8.35	\$26.70	\$0.00	\$77.99
5	85	\$45.62	\$8.35	\$26.70	\$0.00	\$80.67
6	90	\$48.30	\$8.35	\$26.70	\$0.00	\$83.35

Notes:

Apprentice to Journeyworker Ratio:1:4

JACKHAMMER & PAVING BREAKER OPERATOR LABORERS - ZONE 2	12/01/2023	\$38.11	\$9.65	\$17.14	\$0.00	\$64.90
---	------------	---------	--------	---------	--------	---------

For apprentice rates see "Apprentice- LABORER"

LABORER LABORERS - ZONE 2	12/01/2023	\$37.86	\$9.65	\$17.14	\$0.00	\$64.65
------------------------------	------------	---------	--------	---------	--------	---------

Apprentice - LABORER - Zone 2

Effective Date - 12/01/2023

Step	percent	Apprentice Base Wage	Health	Pension	Supplemental Unemployment	Total Rate
1	60	\$22.72	\$9.65	\$16.89	\$0.00	\$49.26
2	70	\$26.50	\$9.65	\$16.89	\$0.00	\$53.04
3	80	\$30.29	\$9.65	\$16.89	\$0.00	\$56.83
4	90	\$34.07	\$9.65	\$16.89	\$0.00	\$60.61

Notes:

Apprentice to Journeyworker Ratio:1:5

Classification	Effective Date	Base Wage	Health	Pension	Supplemental Unemployment	Total Rate
LABORER (HEAVY & HIGHWAY) LABORERS - ZONE 2 (HEAVY & HIGHWAY)	12/01/2023	\$37.86	\$9.65	\$17.14	\$0.00	\$64.65
	06/01/2024	\$39.19	\$9.65	\$17.14	\$0.00	\$65.98
	12/01/2024	\$40.52	\$9.65	\$17.14	\$0.00	\$67.31
	06/01/2025	\$41.91	\$9.65	\$17.14	\$0.00	\$68.70
	12/01/2025	\$43.29	\$9.65	\$17.14	\$0.00	\$70.08
	06/01/2026	\$44.73	\$9.65	\$17.14	\$0.00	\$71.52
	12/01/2026	\$46.17	\$9.65	\$17.14	\$0.00	\$72.96

Apprentice - LABORER (Heavy & Highway) - Zone 2

Effective Date - 12/01/2023

Step	percent	Apprentice Base Wage	Health	Pension	Supplemental Unemployment	Total Rate
1	60	\$22.72	\$9.65	\$17.14	\$0.00	\$49.51
2	70	\$26.50	\$9.65	\$17.14	\$0.00	\$53.29
3	80	\$30.29	\$9.65	\$17.14	\$0.00	\$57.08
4	90	\$34.07	\$9.65	\$17.14	\$0.00	\$60.86

Effective Date - 06/01/2024

Step	percent	Apprentice Base Wage	Health	Pension	Supplemental Unemployment	Total Rate
1	60	\$23.51	\$9.00	\$16.89	\$0.00	\$49.40
2	70	\$27.43	\$9.00	\$16.89	\$0.00	\$53.32
3	80	\$31.35	\$9.00	\$16.89	\$0.00	\$57.24
4	90	\$35.27	\$9.00	\$16.89	\$0.00	\$61.16

Notes:

Apprentice to Journeyworker Ratio:1:5

LABORER: CARPENTER TENDER LABORERS - ZONE 2	12/01/2023	\$37.86	\$9.65	\$17.14	\$0.00	\$64.65
For apprentice rates see "Apprentice- LABORER"						
LABORER: CEMENT FINISHER TENDER LABORERS - ZONE 2	12/01/2023	\$38.36	\$9.40	\$16.89	\$0.00	\$64.65
For apprentice rates see "Apprentice- LABORER"						
LABORER: HAZARDOUS WASTE/ASBESTOS REMOVER LABORERS - ZONE 2	12/01/2023	\$37.95	\$9.65	\$17.20	\$0.00	\$64.80
For apprentice rates see "Apprentice- LABORER"						
LABORER: MASON TENDER LABORERS - ZONE 2	12/01/2023	\$38.11	\$9.65	\$17.14	\$0.00	\$64.90
For apprentice rates see "Apprentice- LABORER"						
LABORER: MASON TENDER (HEAVY & HIGHWAY) LABORERS - ZONE 2 (HEAVY & HIGHWAY)	12/01/2023	\$38.11	\$9.65	\$17.14	\$0.00	\$64.90
	06/01/2024	\$39.44	\$9.65	\$17.14	\$0.00	\$66.23
	12/01/2024	\$40.77	\$9.65	\$17.14	\$0.00	\$67.56
	06/01/2025	\$42.16	\$9.65	\$17.14	\$0.00	\$68.95
	12/01/2025	\$43.54	\$9.65	\$17.14	\$0.00	\$70.33
	06/01/2026	\$44.98	\$9.65	\$17.14	\$0.00	\$71.77
	12/01/2026	\$46.42	\$9.65	\$17.14	\$0.00	\$73.21

For apprentice rates see "Apprentice- LABORER (Heavy and Highway)"

Classification	Effective Date	Base Wage	Health	Pension	Supplemental Unemployment	Total Rate
LABORER: MULTI-TRADE TENDER <i>LABORERS - ZONE 2</i>	12/01/2023	\$37.86	\$9.65	\$17.14	\$0.00	\$64.65
For apprentice rates see "Apprentice- LABORER"						
LABORER: TREE REMOVER <i>LABORERS - ZONE 2</i>	12/01/2023	\$37.86	\$9.65	\$17.14	\$0.00	\$64.65
This classification applies to the removal of standing trees, and the trimming and removal of branches and limbs when related to public works construction or site clearance incidental to construction . For apprentice rates see "Apprentice- LABORER"						
LASER BEAM OPERATOR <i>LABORERS - ZONE 2</i>	12/01/2023	\$38.11	\$9.65	\$17.14	\$0.00	\$64.90
For apprentice rates see "Apprentice- LABORER"						
LASER BEAM OPERATOR (HEAVY & HIGHWAY) <i>LABORERS - ZONE 2 (HEAVY & HIGHWAY)</i>	12/01/2023	\$38.11	\$9.65	\$17.14	\$0.00	\$64.90
	06/01/2024	\$39.44	\$9.65	\$17.14	\$0.00	\$66.23
	12/01/2024	\$40.77	\$9.65	\$17.14	\$0.00	\$67.56
	06/01/2025	\$42.16	\$9.65	\$17.14	\$0.00	\$68.95
	12/01/2025	\$43.54	\$9.65	\$17.14	\$0.00	\$70.33
	06/01/2026	\$44.98	\$9.65	\$17.14	\$0.00	\$71.77
	12/01/2026	\$46.42	\$9.65	\$17.14	\$0.00	\$73.21
For apprentice rates see "Apprentice- LABORER (Heavy and Highway)"						
MARBLE & TILE FINISHERS <i>BRICKLAYERS LOCAL 3 - MARBLE & TILE</i>	02/01/2024	\$47.89	\$11.49	\$21.37	\$0.00	\$80.75
	08/01/2024	\$49.57	\$11.49	\$21.37	\$0.00	\$82.43
	02/01/2025	\$50.61	\$11.49	\$21.37	\$0.00	\$83.47
	08/01/2025	\$52.33	\$11.49	\$21.37	\$0.00	\$85.19
	02/01/2026	\$53.41	\$11.49	\$21.37	\$0.00	\$86.27
	08/01/2026	\$55.17	\$11.49	\$21.37	\$0.00	\$88.03
	02/01/2027	\$56.29	\$11.49	\$21.37	\$0.00	\$89.15

Apprentice - MARBLE & TILE FINISHER - Local 3 Marble & Tile

Effective Date - 02/01/2024

Step	percent	Apprentice Base Wage	Health	Pension	Supplemental Unemployment	Total Rate
1	50	\$23.95	\$11.49	\$21.37	\$0.00	\$56.81
2	60	\$28.73	\$11.49	\$21.37	\$0.00	\$61.59
3	70	\$33.52	\$11.49	\$21.37	\$0.00	\$66.38
4	80	\$38.31	\$11.49	\$21.37	\$0.00	\$71.17
5	90	\$43.10	\$11.49	\$21.37	\$0.00	\$75.96

Effective Date - 08/01/2024

Step	percent	Apprentice Base Wage	Health	Pension	Supplemental Unemployment	Total Rate
1	50	\$24.79	\$11.49	\$21.37	\$0.00	\$57.65
2	60	\$29.74	\$11.49	\$21.37	\$0.00	\$62.60
3	70	\$34.70	\$11.49	\$21.37	\$0.00	\$67.56
4	80	\$39.66	\$11.49	\$21.37	\$0.00	\$72.52
5	90	\$44.61	\$11.49	\$21.37	\$0.00	\$77.47

Notes:

Apprentice to Journeyworker Ratio:1:3

Classification	Effective Date	Base Wage	Health	Pension	Supplemental Unemployment	Total Rate
MARBLE MASONS, TILELAYERS & TERRAZZO MECH <i>BRICKLAYERS LOCAL 3 - MARBLE & TILE</i>	02/01/2024	\$62.42	\$11.49	\$23.56	\$0.00	\$97.47
	08/01/2024	\$64.52	\$11.49	\$23.56	\$0.00	\$99.57
	02/01/2025	\$65.82	\$11.49	\$23.56	\$0.00	\$100.87
	08/01/2025	\$67.97	\$11.49	\$23.56	\$0.00	\$103.02
	02/01/2026	\$69.32	\$11.49	\$23.56	\$0.00	\$104.37
	08/01/2026	\$71.52	\$11.49	\$23.56	\$0.00	\$106.57
	02/01/2027	\$72.92	\$11.49	\$23.56	\$0.00	\$107.97

Apprentice - MARBLE-TILE-TERRAZZO MECHANIC - Local 3 Marble & Tile

Effective Date - 02/01/2024

Step	percent	Apprentice Base Wage	Health	Pension	Supplemental Unemployment	Total Rate
1	50	\$31.21	\$11.49	\$23.56	\$0.00	\$66.26
2	60	\$37.45	\$11.49	\$23.56	\$0.00	\$72.50
3	70	\$43.69	\$11.49	\$23.56	\$0.00	\$78.74
4	80	\$49.94	\$11.49	\$23.56	\$0.00	\$84.99
5	90	\$56.18	\$11.49	\$23.56	\$0.00	\$91.23

Effective Date - 08/01/2024

Step	percent	Apprentice Base Wage	Health	Pension	Supplemental Unemployment	Total Rate
1	50	\$32.26	\$11.49	\$23.56	\$0.00	\$67.31
2	60	\$38.71	\$11.49	\$23.56	\$0.00	\$73.76
3	70	\$45.16	\$11.49	\$23.56	\$0.00	\$80.21
4	80	\$51.62	\$11.49	\$23.56	\$0.00	\$86.67
5	90	\$58.07	\$11.49	\$23.56	\$0.00	\$93.12

Notes:

Apprentice to Journeyworker Ratio:1:5

MECH. SWEEPER OPERATOR (ON CONST. SITES) <i>OPERATING ENGINEERS LOCAL 4</i>	12/01/2023	\$54.43	\$15.00	\$16.40	\$0.00	\$85.83
	06/01/2024	\$55.71	\$15.00	\$16.40	\$0.00	\$87.11
	12/01/2024	\$57.15	\$15.00	\$16.40	\$0.00	\$88.55
	06/01/2025	\$58.43	\$15.00	\$16.40	\$0.00	\$89.83
	12/01/2025	\$59.87	\$15.00	\$16.40	\$0.00	\$91.27
	06/01/2026	\$61.15	\$15.00	\$16.40	\$0.00	\$92.55
	12/01/2026	\$62.59	\$15.00	\$16.40	\$0.00	\$93.99

For apprentice rates see "Apprentice- OPERATING ENGINEERS"

MECHANICS MAINTENANCE <i>OPERATING ENGINEERS LOCAL 4</i>	12/01/2023	\$54.43	\$15.00	\$16.40	\$0.00	\$85.83
	06/01/2024	\$55.71	\$15.00	\$16.40	\$0.00	\$87.11
	12/01/2024	\$57.15	\$15.00	\$16.40	\$0.00	\$88.55
	06/01/2025	\$58.43	\$15.00	\$16.40	\$0.00	\$89.83
	12/01/2025	\$59.87	\$15.00	\$16.40	\$0.00	\$91.27
	06/01/2026	\$61.15	\$15.00	\$16.40	\$0.00	\$92.55
	12/01/2026	\$62.59	\$15.00	\$16.40	\$0.00	\$93.99

For apprentice rates see "Apprentice- OPERATING ENGINEERS"

Classification	Effective Date	Base Wage	Health	Pension	Supplemental Unemployment	Total Rate
MILLWRIGHT (Zone 2)	01/01/2024	\$42.76	\$10.08	\$21.47	\$0.00	\$74.31
MILLWRIGHTS LOCAL 1121 - Zone 2	01/06/2025	\$45.09	\$10.08	\$21.47	\$0.00	\$76.64
	01/05/2026	\$47.42	\$10.08	\$21.47	\$0.00	\$78.97

Apprentice - MILLWRIGHT - Local 1121 Zone 2

Effective Date - 01/01/2024

Step	percent	Apprentice Base Wage	Health	Pension	Supplemental Unemployment	Total Rate
1	55	\$23.52	\$10.08	\$5.50	\$0.00	\$39.10
2	65	\$27.79	\$10.08	\$6.50	\$0.00	\$44.37
3	75	\$32.07	\$10.08	\$18.97	\$0.00	\$61.12
4	85	\$36.35	\$10.08	\$19.97	\$0.00	\$66.40

Effective Date - 01/06/2025

Step	percent	Apprentice Base Wage	Health	Pension	Supplemental Unemployment	Total Rate
1	55	\$24.80	\$10.08	\$5.50	\$0.00	\$40.38
2	65	\$29.31	\$10.08	\$6.50	\$0.00	\$45.89
3	75	\$33.82	\$10.08	\$18.97	\$0.00	\$62.87
4	85	\$38.33	\$10.08	\$19.97	\$0.00	\$68.38

Notes: Step 1&2 Appr. indentured after 1/6/2020 receive no pension, but do receive annuity. (Step 1 \$5.72, Step 2 \$6.66)
Steps are 2,000 hours

Apprentice to Journeyworker Ratio:1:4

MORTAR MIXER LABORERS - ZONE 2	12/01/2023	\$38.11	\$9.65	\$17.14	\$0.00	\$64.90
-----------------------------------	------------	---------	--------	---------	--------	---------

For apprentice rates see "Apprentice- LABORER"

OILER (OTHER THAN TRUCK CRANES,GRADALLS) OPERATING ENGINEERS LOCAL 4	12/01/2023	\$24.41	\$15.00	\$16.40	\$0.00	\$55.81
	06/01/2024	\$25.01	\$15.00	\$16.40	\$0.00	\$56.41
	12/01/2024	\$25.67	\$15.00	\$16.40	\$0.00	\$57.07
	06/01/2025	\$26.27	\$15.00	\$16.40	\$0.00	\$57.67
	12/01/2025	\$26.93	\$15.00	\$16.40	\$0.00	\$58.33
	06/01/2026	\$27.52	\$15.00	\$16.40	\$0.00	\$58.92
	12/01/2026	\$28.19	\$15.00	\$16.40	\$0.00	\$59.59

For apprentice rates see "Apprentice- OPERATING ENGINEERS"

OILER (TRUCK CRANES, GRADALLS) OPERATING ENGINEERS LOCAL 4	12/01/2023	\$29.86	\$15.00	\$16.40	\$0.00	\$61.26
	06/01/2024	\$30.58	\$15.00	\$16.40	\$0.00	\$61.98
	12/01/2024	\$31.38	\$15.00	\$16.40	\$0.00	\$62.78
	06/01/2025	\$32.10	\$15.00	\$16.40	\$0.00	\$63.50
	12/01/2025	\$32.90	\$15.00	\$16.40	\$0.00	\$64.30
	06/01/2026	\$33.62	\$15.00	\$16.40	\$0.00	\$65.02
	12/01/2026	\$34.42	\$15.00	\$16.40	\$0.00	\$65.82

For apprentice rates see "Apprentice- OPERATING ENGINEERS"

Classification	Effective Date	Base Wage	Health	Pension	Supplemental Unemployment	Total Rate
OTHER POWER DRIVEN EQUIPMENT - CLASS II <i>OPERATING ENGINEERS LOCAL 4</i>	12/01/2023	\$54.43	\$15.00	\$16.40	\$0.00	\$85.83
	06/01/2024	\$55.71	\$15.00	\$16.40	\$0.00	\$87.11
	12/01/2024	\$57.15	\$15.00	\$16.40	\$0.00	\$88.55
	06/01/2025	\$58.43	\$15.00	\$16.40	\$0.00	\$89.83
	12/01/2025	\$59.87	\$15.00	\$16.40	\$0.00	\$91.27
	06/01/2026	\$61.15	\$15.00	\$16.40	\$0.00	\$92.55
	12/01/2026	\$62.59	\$15.00	\$16.40	\$0.00	\$93.99
For apprentice rates see "Apprentice- OPERATING ENGINEERS"						

PAINTER (BRIDGES/TANKS) <i>PAINTERS LOCAL 35 - ZONE 2</i>	01/01/2024	\$56.06	\$9.95	\$23.95	\$0.00	\$89.96
	07/01/2024	\$57.26	\$9.95	\$23.95	\$0.00	\$91.16
	01/01/2025	\$58.46	\$9.95	\$23.95	\$0.00	\$92.36

Apprentice - PAINTER Local 35 - BRIDGES/TANKS

Effective Date - 01/01/2024		Apprentice Base Wage	Health	Pension	Supplemental Unemployment	Total Rate
Step	percent					
1	50	\$28.03	\$9.95	\$0.00	\$0.00	\$37.98
2	55	\$30.83	\$9.95	\$6.66	\$0.00	\$47.44
3	60	\$33.64	\$9.95	\$7.26	\$0.00	\$50.85
4	65	\$36.44	\$9.95	\$7.87	\$0.00	\$54.26
5	70	\$39.24	\$9.95	\$20.32	\$0.00	\$69.51
6	75	\$42.05	\$9.95	\$20.93	\$0.00	\$72.93
7	80	\$44.85	\$9.95	\$21.53	\$0.00	\$76.33
8	90	\$50.45	\$9.95	\$22.74	\$0.00	\$83.14

Effective Date - 07/01/2024		Apprentice Base Wage	Health	Pension	Supplemental Unemployment	Total Rate
Step	percent					
1	50	\$28.63	\$9.95	\$0.00	\$0.00	\$38.58
2	55	\$31.49	\$9.95	\$6.66	\$0.00	\$48.10
3	60	\$34.36	\$9.95	\$7.26	\$0.00	\$51.57
4	65	\$37.22	\$9.95	\$7.87	\$0.00	\$55.04
5	70	\$40.08	\$9.95	\$20.32	\$0.00	\$70.35
6	75	\$42.95	\$9.95	\$20.93	\$0.00	\$73.83
7	80	\$45.81	\$9.95	\$21.53	\$0.00	\$77.29
8	90	\$51.53	\$9.95	\$22.74	\$0.00	\$84.22

Notes:
Steps are 750 hrs.

Apprentice to Journeyworker Ratio:1:1

PAINTER (SPRAY OR SANDBLAST, NEW) *	01/01/2024	\$46.96	\$9.95	\$23.95	\$0.00	\$80.86
* If 30% or more of surfaces to be painted are new construction, NEW paint rate shall be used. <i>PAINTERS LOCAL 35 - ZONE 2</i>	07/01/2024	\$48.16	\$9.95	\$23.95	\$0.00	\$82.06
	01/01/2025	\$49.36	\$9.95	\$23.95	\$0.00	\$83.26

Classification

Effective Date Base Wage Health Pension Supplemental Unemployment Total Rate

Apprentice - PAINTER Local 35 Zone 2 - Spray/Sandblast - New

Effective Date - 01/01/2024

Step	percent	Apprentice Base Wage	Health	Pension	Supplemental Unemployment	Total Rate
1	50	\$23.48	\$9.95	\$0.00	\$0.00	\$33.43
2	55	\$25.83	\$9.95	\$6.66	\$0.00	\$42.44
3	60	\$28.18	\$9.95	\$7.26	\$0.00	\$45.39
4	65	\$30.52	\$9.95	\$7.87	\$0.00	\$48.34
5	70	\$32.87	\$9.95	\$20.32	\$0.00	\$63.14
6	75	\$35.22	\$9.95	\$20.93	\$0.00	\$66.10
7	80	\$37.57	\$9.95	\$21.53	\$0.00	\$69.05
8	90	\$42.26	\$9.95	\$22.74	\$0.00	\$74.95

Effective Date - 07/01/2024

Step	percent	Apprentice Base Wage	Health	Pension	Supplemental Unemployment	Total Rate
1	50	\$24.08	\$9.95	\$0.00	\$0.00	\$34.03
2	55	\$26.49	\$9.95	\$6.66	\$0.00	\$43.10
3	60	\$28.90	\$9.95	\$7.26	\$0.00	\$46.11
4	65	\$31.30	\$9.95	\$7.87	\$0.00	\$49.12
5	70	\$33.71	\$9.95	\$20.32	\$0.00	\$63.98
6	75	\$36.12	\$9.95	\$20.93	\$0.00	\$67.00
7	80	\$38.53	\$9.95	\$21.53	\$0.00	\$70.01
8	90	\$43.34	\$9.95	\$22.74	\$0.00	\$76.03

Notes:

Steps are 750 hrs.

Apprentice to Journeyworker Ratio:1:1

PAINTER (SPRAY OR SANDBLAST, REPAINT)	01/01/2024	\$45.02	\$9.95	\$23.95	\$0.00	\$78.92
PAINTERS LOCAL 35 - ZONE 2	07/01/2024	\$46.22	\$9.95	\$23.95	\$0.00	\$80.12
	01/01/2025	\$47.42	\$9.95	\$23.95	\$0.00	\$81.32

Classification

Effective Date Base Wage Health Pension Supplemental Unemployment Total Rate

Apprentice - PAINTER Local 35 Zone 2 - Spray/Sandblast - Repaint

Effective Date - 01/01/2024

Step	percent	Apprentice Base Wage	Health	Pension	Supplemental Unemployment	Total Rate
1	50	\$22.51	\$9.95	\$0.00	\$0.00	\$32.46
2	55	\$24.76	\$9.95	\$6.66	\$0.00	\$41.37
3	60	\$27.01	\$9.95	\$7.26	\$0.00	\$44.22
4	65	\$29.26	\$9.95	\$7.87	\$0.00	\$47.08
5	70	\$31.51	\$9.95	\$20.32	\$0.00	\$61.78
6	75	\$33.77	\$9.95	\$20.93	\$0.00	\$64.65
7	80	\$36.02	\$9.95	\$21.53	\$0.00	\$67.50
8	90	\$40.52	\$9.95	\$22.74	\$0.00	\$73.21

Effective Date - 07/01/2024

Step	percent	Apprentice Base Wage	Health	Pension	Supplemental Unemployment	Total Rate
1	50	\$23.11	\$9.95	\$0.00	\$0.00	\$33.06
2	55	\$25.42	\$9.95	\$6.66	\$0.00	\$42.03
3	60	\$27.73	\$9.95	\$7.26	\$0.00	\$44.94
4	65	\$30.04	\$9.95	\$7.87	\$0.00	\$47.86
5	70	\$32.35	\$9.95	\$20.32	\$0.00	\$62.62
6	75	\$34.67	\$9.95	\$20.93	\$0.00	\$65.55
7	80	\$36.98	\$9.95	\$21.53	\$0.00	\$68.46
8	90	\$41.60	\$9.95	\$22.74	\$0.00	\$74.29

Notes:

Steps are 750 hrs.

Apprentice to Journeyworker Ratio:1:1

PAINTER / TAPER (BRUSH, NEW) *	01/01/2024	\$45.56	\$9.95	\$23.95	\$0.00	\$79.46
* If 30% or more of surfaces to be painted are new construction, NEW paint rate shall be used. PAINTERS LOCAL 35 - ZONE 2	07/01/2024	\$46.76	\$9.95	\$23.95	\$0.00	\$80.66
	01/01/2025	\$47.96	\$9.95	\$23.95	\$0.00	\$81.86

Classification

Effective Date Base Wage Health Pension Supplemental Unemployment Total Rate

Apprentice - PAINTER - Local 35 Zone 2 - BRUSH NEW

Effective Date - 01/01/2024

Step	percent	Apprentice Base Wage	Health	Pension	Supplemental Unemployment	Total Rate
1	50	\$22.78	\$9.95	\$0.00	\$0.00	\$32.73
2	55	\$25.06	\$9.95	\$6.66	\$0.00	\$41.67
3	60	\$27.34	\$9.95	\$7.26	\$0.00	\$44.55
4	65	\$29.61	\$9.95	\$7.87	\$0.00	\$47.43
5	70	\$31.89	\$9.95	\$20.32	\$0.00	\$62.16
6	75	\$34.17	\$9.95	\$20.93	\$0.00	\$65.05
7	80	\$36.45	\$9.95	\$21.53	\$0.00	\$67.93
8	90	\$41.00	\$9.95	\$22.74	\$0.00	\$73.69

Effective Date - 07/01/2024

Step	percent	Apprentice Base Wage	Health	Pension	Supplemental Unemployment	Total Rate
1	50	\$23.38	\$9.95	\$0.00	\$0.00	\$33.33
2	55	\$25.72	\$9.95	\$6.66	\$0.00	\$42.33
3	60	\$28.06	\$9.95	\$7.26	\$0.00	\$45.27
4	65	\$30.39	\$9.95	\$7.87	\$0.00	\$48.21
5	70	\$32.73	\$9.95	\$20.32	\$0.00	\$63.00
6	75	\$35.07	\$9.95	\$20.93	\$0.00	\$65.95
7	80	\$37.41	\$9.95	\$21.53	\$0.00	\$68.89
8	90	\$42.08	\$9.95	\$22.74	\$0.00	\$74.77

Notes:

Steps are 750 hrs.

Apprentice to Journeyworker Ratio:1:1

PAINTER / TAPER (BRUSH, REPAINT)	01/01/2024	\$43.62	\$9.95	\$23.95	\$0.00	\$77.52
PAINTERS LOCAL 35 - ZONE 2	07/01/2024	\$44.82	\$9.95	\$23.95	\$0.00	\$78.72
	01/01/2025	\$46.02	\$9.95	\$23.95	\$0.00	\$79.92

Classification

Effective Date Base Wage Health Pension Supplemental Unemployment Total Rate

Apprentice - PAINTER Local 35 Zone 2 - BRUSH REPAINT

Effective Date - 01/01/2024

Step	percent	Apprentice Base Wage	Health	Pension	Supplemental Unemployment	Total Rate
1	50	\$21.81	\$9.95	\$0.00	\$0.00	\$31.76
2	55	\$23.99	\$9.95	\$6.66	\$0.00	\$40.60
3	60	\$26.17	\$9.95	\$7.26	\$0.00	\$43.38
4	65	\$28.35	\$9.95	\$7.87	\$0.00	\$46.17
5	70	\$30.53	\$9.95	\$20.32	\$0.00	\$60.80
6	75	\$32.72	\$9.95	\$20.93	\$0.00	\$63.60
7	80	\$34.90	\$9.95	\$21.53	\$0.00	\$66.38
8	90	\$39.26	\$9.95	\$22.74	\$0.00	\$71.95

Effective Date - 07/01/2024

Step	percent	Apprentice Base Wage	Health	Pension	Supplemental Unemployment	Total Rate
1	50	\$22.41	\$9.95	\$0.00	\$0.00	\$32.36
2	55	\$24.65	\$9.95	\$6.66	\$0.00	\$41.26
3	60	\$26.89	\$9.95	\$7.26	\$0.00	\$44.10
4	65	\$29.13	\$9.95	\$7.87	\$0.00	\$46.95
5	70	\$31.37	\$9.95	\$20.32	\$0.00	\$61.64
6	75	\$33.62	\$9.95	\$20.93	\$0.00	\$64.50
7	80	\$35.86	\$9.95	\$21.53	\$0.00	\$67.34
8	90	\$40.34	\$9.95	\$22.74	\$0.00	\$73.03

Notes:

Steps are 750 hrs.

Apprentice to Journeyworker Ratio:1:1

PAINTER TRAFFIC MARKINGS (HEAVY/HIGHWAY)	12/01/2023	\$37.86	\$9.65	\$17.14	\$0.00	\$64.65
LABORERS - ZONE 2 (HEAVY & HIGHWAY)	06/01/2024	\$39.19	\$9.65	\$17.14	\$0.00	\$65.98
	12/01/2024	\$40.52	\$9.65	\$17.14	\$0.00	\$67.31
	06/01/2025	\$41.91	\$9.65	\$17.14	\$0.00	\$68.70
	12/01/2025	\$43.29	\$9.65	\$17.14	\$0.00	\$70.08
	06/01/2026	\$44.73	\$9.65	\$17.14	\$0.00	\$71.52
	12/01/2026	\$46.17	\$9.65	\$17.14	\$0.00	\$72.96

For apprentice rates see "Apprentice- LABORER (Heavy and Highway)

PANEL & PICKUP TRUCKS DRIVER	01/01/2024	\$38.78	\$15.07	\$18.67	\$0.00	\$72.52
TEAMSTERS JOINT COUNCIL NO. 10 ZONE B	06/01/2024	\$39.78	\$15.07	\$18.67	\$0.00	\$73.52
	12/01/2024	\$39.78	\$15.07	\$20.17	\$0.00	\$75.02
	01/01/2025	\$39.78	\$15.57	\$20.17	\$0.00	\$75.52
	06/01/2025	\$40.78	\$15.57	\$20.17	\$0.00	\$76.52
	12/01/2025	\$40.78	\$15.57	\$21.78	\$0.00	\$78.13
	01/01/2026	\$40.78	\$16.17	\$21.78	\$0.00	\$78.73
	06/01/2026	\$41.78	\$16.17	\$21.78	\$0.00	\$79.73
	12/01/2026	\$41.78	\$16.17	\$23.52	\$0.00	\$81.47
	01/01/2027	\$41.78	\$16.77	\$23.52	\$0.00	\$82.07

Classification	Effective Date	Base Wage	Health	Pension	Supplemental Unemployment	Total Rate
PIER AND DOCK CONSTRUCTOR (UNDERPINNING AND DECK) <i>PILE DRIVER LOCAL 56 (ZONE 1)</i> For apprentice rates see "Apprentice- PILE DRIVER"	08/01/2020	\$49.07	\$9.40	\$23.12	\$0.00	\$81.59
PILE DRIVER <i>PILE DRIVER LOCAL 56 (ZONE 1)</i>	08/01/2020	\$49.07	\$9.40	\$23.12	\$0.00	\$81.59

Apprentice - PILE DRIVER - Local 56 Zone 1

Effective Date - 08/01/2020

Step	percent	Apprentice Base Wage	Health	Pension	Supplemental Unemployment	Total Rate
1	50	\$24.54	\$9.40	\$23.12	\$0.00	\$57.06
2	60	\$29.44	\$9.40	\$23.12	\$0.00	\$61.96
3	70	\$34.35	\$9.40	\$23.12	\$0.00	\$66.87
4	75	\$36.80	\$9.40	\$23.12	\$0.00	\$69.32
5	80	\$39.26	\$9.40	\$23.12	\$0.00	\$71.78
6	80	\$39.26	\$9.40	\$23.12	\$0.00	\$71.78
7	90	\$44.16	\$9.40	\$23.12	\$0.00	\$76.68
8	90	\$44.16	\$9.40	\$23.12	\$0.00	\$76.68

Notes:

% Indentured After 10/1/17; 45/45/55/55/70/70/80/80
Step 1&2 \$34.01/ 3&4 \$41.46/ 5&6 \$62.80/ 7&8 \$69.25

Apprentice to Journeyworker Ratio:1:5

PIPEFITTER & STEAMFITTER <i>PIPEFITTERS LOCAL 537</i>	09/01/2023	\$63.48	\$12.70	\$21.80	\$0.00	\$97.98
	03/01/2024	\$65.28	\$12.70	\$21.80	\$0.00	\$99.78
	09/01/2024	\$67.08	\$12.70	\$21.80	\$0.00	\$101.58
	03/01/2025	\$68.88	\$12.70	\$21.80	\$0.00	\$103.38

Classification

Effective Date Base Wage Health Pension Supplemental Unemployment Total Rate

Apprentice - PIPEFITTER - Local 537

Effective Date - 09/01/2023

Step	percent	Apprentice Base Wage	Health	Pension	Supplemental Unemployment	Total Rate
1	40	\$25.39	\$12.70	\$9.05	\$0.00	\$47.14
2	45	\$28.57	\$12.70	\$21.50	\$0.00	\$62.77
3	60	\$38.09	\$12.70	\$21.50	\$0.00	\$72.29
4	70	\$44.44	\$12.70	\$21.50	\$0.00	\$78.64
5	80	\$50.78	\$12.70	\$21.50	\$0.00	\$84.98

Effective Date - 03/01/2024

Step	percent	Apprentice Base Wage	Health	Pension	Supplemental Unemployment	Total Rate
1	40	\$26.11	\$12.70	\$9.05	\$0.00	\$47.86
2	45	\$29.38	\$12.70	\$21.50	\$0.00	\$63.58
3	60	\$39.17	\$12.70	\$21.50	\$0.00	\$73.37
4	70	\$45.70	\$12.70	\$21.50	\$0.00	\$79.90
5	80	\$52.22	\$12.70	\$21.50	\$0.00	\$86.42

Notes:

** 1:3; 3:15; 1:10 thereafter / Steps are 1 yr.
 Refrig/AC Mechanic **1:1;1:2;2:4;3:6;4:8;5:10;6:12;7:14;8:17;9:20;10:23(Max)

Apprentice to Journeyworker Ratio:**

PIPELAYER LABORERS - ZONE 2	12/01/2023	\$38.11	\$9.65	\$17.14	\$0.00	\$64.90
--------------------------------	------------	---------	--------	---------	--------	---------

For apprentice rates see "Apprentice- LABORER"

PIPELAYER (HEAVY & HIGHWAY) LABORERS - ZONE 2 (HEAVY & HIGHWAY)	12/01/2023	\$38.11	\$9.65	\$17.14	\$0.00	\$64.90
	06/01/2024	\$39.44	\$9.65	\$17.14	\$0.00	\$66.23
	12/01/2024	\$40.77	\$9.65	\$17.14	\$0.00	\$67.56
	06/01/2025	\$42.16	\$9.65	\$17.14	\$0.00	\$68.95
	12/01/2025	\$43.54	\$9.65	\$17.14	\$0.00	\$70.33
	06/01/2026	\$44.98	\$9.65	\$17.14	\$0.00	\$71.77
	12/01/2026	\$46.42	\$9.65	\$17.14	\$0.00	\$73.21

For apprentice rates see "Apprentice- LABORER (Heavy and Highway)"

PLUMBERS & GASFITTERS PLUMBERS & GASFITTERS LOCAL 12	09/03/2023	\$66.44	\$14.07	\$18.86	\$0.00	\$99.37
	03/03/2024	\$68.24	\$14.07	\$18.86	\$0.00	\$101.17
	09/01/2024	\$70.04	\$14.07	\$18.86	\$0.00	\$102.97
	03/02/2025	\$71.34	\$14.32	\$19.11	\$0.00	\$104.77

Classification

Effective Date Base Wage Health Pension Supplemental Unemployment Total Rate

Apprentice - PLUMBER/GASFITTER - Local 12

Effective Date - 09/03/2023

Step	percent	Apprentice Base Wage	Health	Pension	Supplemental Unemployment	Total Rate
1	35	\$23.25	\$14.07	\$6.80	\$0.00	\$44.12
2	40	\$26.58	\$14.07	\$7.72	\$0.00	\$48.37
3	55	\$36.54	\$14.07	\$10.51	\$0.00	\$61.12
4	65	\$43.19	\$14.07	\$12.36	\$0.00	\$69.62
5	75	\$49.83	\$14.07	\$14.22	\$0.00	\$78.12

Effective Date - 03/03/2024

Step	percent	Apprentice Base Wage	Health	Pension	Supplemental Unemployment	Total Rate
1	35	\$23.88	\$14.07	\$6.80	\$0.00	\$44.75
2	40	\$27.30	\$14.07	\$7.72	\$0.00	\$49.09
3	55	\$37.53	\$14.07	\$10.51	\$0.00	\$62.11
4	65	\$44.36	\$14.07	\$12.36	\$0.00	\$70.79
5	75	\$51.18	\$14.07	\$14.22	\$0.00	\$79.47

Notes:
 ** 1:2; 2:6; 3:10; 4:14; 5:19/Steps are 1 yr
 Step4 with lic\$69.00, Step5 with lic\$76.87

Apprentice to Journeyworker Ratio:**

PNEUMATIC CONTROLS (TEMP.) PIPEFITTERS LOCAL 537	09/01/2023	\$63.48	\$12.70	\$21.80	\$0.00	\$97.98
	03/01/2024	\$65.28	\$12.70	\$21.80	\$0.00	\$99.78
	09/01/2024	\$67.08	\$12.70	\$21.80	\$0.00	\$101.58
	03/01/2025	\$68.88	\$12.70	\$21.80	\$0.00	\$103.38

For apprentice rates see "Apprentice- PIPEFITTER" or "PLUMBER/PIPEFITTER"

PNEUMATIC DRILL/TOOL OPERATOR LABORERS - ZONE 2	12/01/2023	\$38.11	\$9.65	\$17.14	\$0.00	\$64.90
--	------------	---------	--------	---------	--------	---------

For apprentice rates see "Apprentice- LABORER"

PNEUMATIC DRILL/TOOL OPERATOR (HEAVY & HIGHWAY) LABORERS - ZONE 2 (HEAVY & HIGHWAY)	12/01/2023	\$38.11	\$9.65	\$17.14	\$0.00	\$64.90
	06/01/2024	\$39.44	\$9.65	\$17.14	\$0.00	\$66.23
	12/01/2024	\$40.77	\$9.65	\$17.14	\$0.00	\$67.56
	06/01/2025	\$42.16	\$9.65	\$17.14	\$0.00	\$68.95
	12/01/2025	\$43.54	\$9.65	\$17.14	\$0.00	\$70.33
	06/01/2026	\$44.98	\$9.65	\$17.14	\$0.00	\$71.77
	12/01/2026	\$46.42	\$9.65	\$17.14	\$0.00	\$73.21

For apprentice rates see "Apprentice- LABORER (Heavy and Highway)"

POWDERMAN & BLASTER LABORERS - ZONE 2	12/01/2023	\$38.86	\$9.65	\$17.14	\$0.00	\$65.65
--	------------	---------	--------	---------	--------	---------

For apprentice rates see "Apprentice- LABORER"

Classification	Effective Date	Base Wage	Health	Pension	Supplemental Unemployment	Total Rate
POWDERMAN & BLASTER (HEAVY & HIGHWAY) <i>LABORERS - ZONE 2 (HEAVY & HIGHWAY)</i>	12/01/2023	\$39.36	\$9.40	\$16.89	\$0.00	\$65.65
	06/01/2024	\$40.69	\$9.40	\$16.89	\$0.00	\$66.98
	12/01/2024	\$42.02	\$9.40	\$16.89	\$0.00	\$68.31
	06/01/2025	\$43.41	\$9.40	\$16.89	\$0.00	\$69.70
	12/01/2025	\$44.79	\$9.40	\$16.89	\$0.00	\$71.08
	06/01/2026	\$46.23	\$9.40	\$16.89	\$0.00	\$72.52
	12/01/2026	\$47.67	\$9.40	\$16.89	\$0.00	\$73.96
For apprentice rates see "Apprentice- LABORER (Heavy and Highway)						
POWER SHOVEL/DERRICK/TRENCHING MACHINE <i>OPERATING ENGINEERS LOCAL 4</i>	12/01/2023	\$55.03	\$15.00	\$16.40	\$0.00	\$86.43
	06/01/2024	\$56.33	\$15.00	\$16.40	\$0.00	\$87.73
	12/01/2024	\$57.78	\$15.00	\$16.40	\$0.00	\$89.18
	06/01/2025	\$59.08	\$15.00	\$16.40	\$0.00	\$90.48
	12/01/2025	\$60.53	\$15.00	\$16.40	\$0.00	\$91.93
	06/01/2026	\$61.83	\$15.00	\$16.40	\$0.00	\$93.23
	12/01/2026	\$63.28	\$15.00	\$16.40	\$0.00	\$94.68
For apprentice rates see "Apprentice- OPERATING ENGINEERS"						
PUMP OPERATOR (CONCRETE) <i>OPERATING ENGINEERS LOCAL 4</i>	12/01/2023	\$54.43	\$15.00	\$16.40	\$0.00	\$85.83
	06/01/2024	\$55.71	\$15.00	\$16.40	\$0.00	\$87.11
	12/01/2024	\$57.15	\$15.00	\$16.40	\$0.00	\$88.55
	06/01/2025	\$58.43	\$15.00	\$16.40	\$0.00	\$89.83
	12/01/2025	\$59.87	\$15.00	\$16.40	\$0.00	\$91.27
	06/01/2026	\$61.15	\$15.00	\$16.40	\$0.00	\$92.55
	12/01/2026	\$62.59	\$15.00	\$16.40	\$0.00	\$93.99
For apprentice rates see "Apprentice- OPERATING ENGINEERS"						
PUMP OPERATOR (DEWATERING, OTHER) <i>OPERATING ENGINEERS LOCAL 4</i>	12/01/2023	\$35.62	\$15.00	\$16.40	\$0.00	\$67.02
	06/01/2024	\$36.47	\$15.00	\$16.40	\$0.00	\$67.87
	12/01/2024	\$37.42	\$15.00	\$16.40	\$0.00	\$68.82
	06/01/2025	\$38.27	\$15.00	\$16.40	\$0.00	\$69.67
	12/01/2025	\$39.22	\$15.00	\$16.40	\$0.00	\$70.62
	06/01/2026	\$40.08	\$15.00	\$16.40	\$0.00	\$71.48
	12/01/2026	\$41.03	\$15.00	\$16.40	\$0.00	\$72.43
For apprentice rates see "Apprentice- OPERATING ENGINEERS"						
READY-MIX CONCRETE DRIVER <i>TEAMSTERS 170 - Dauphinais (Bellingham)</i>	01/01/2024	\$27.00	\$10.76	\$5.45	\$0.00	\$43.21
	12/01/2024	\$27.60	\$11.26	\$6.15	\$0.00	\$45.01
	01/01/2025	\$27.60	\$11.26	\$6.15	\$0.00	\$45.01
RECLAIMERS <i>OPERATING ENGINEERS LOCAL 4</i>	12/01/2023	\$54.43	\$15.00	\$16.40	\$0.00	\$85.83
	06/01/2024	\$55.71	\$15.00	\$16.40	\$0.00	\$87.11
	12/01/2024	\$57.15	\$15.00	\$16.40	\$0.00	\$88.55
	06/01/2025	\$58.43	\$15.00	\$16.40	\$0.00	\$89.83
	12/01/2025	\$59.87	\$15.00	\$16.40	\$0.00	\$91.27
	06/01/2026	\$61.15	\$15.00	\$16.40	\$0.00	\$92.55
	12/01/2026	\$62.59	\$15.00	\$16.40	\$0.00	\$93.99
For apprentice rates see "Apprentice- OPERATING ENGINEERS"						
RIDE-ON MOTORIZED BUGGY OPERATOR <i>LABORERS - ZONE 2</i>	12/01/2023	\$38.11	\$9.65	\$17.14	\$0.00	\$64.90
For apprentice rates see "Apprentice- LABORER"						

Classification	Effective Date	Base Wage	Health	Pension	Supplemental Unemployment	Total Rate
ROLLER/SPREADER/MULCHING MACHINE <i>OPERATING ENGINEERS LOCAL 4</i>	12/01/2023	\$54.43	\$15.00	\$16.40	\$0.00	\$85.83
	06/01/2024	\$55.71	\$15.00	\$16.40	\$0.00	\$87.11
	12/01/2024	\$57.15	\$15.00	\$16.40	\$0.00	\$88.55
	06/01/2025	\$58.43	\$15.00	\$16.40	\$0.00	\$89.83
	12/01/2025	\$59.87	\$15.00	\$16.40	\$0.00	\$91.27
	06/01/2026	\$61.15	\$15.00	\$16.40	\$0.00	\$92.55
	12/01/2026	\$62.59	\$15.00	\$16.40	\$0.00	\$93.99

For apprentice rates see "Apprentice- OPERATING ENGINEERS"

ROOFER (Inc.Roofing &Roofing Damproofg) <i>ROOFERS LOCAL 33</i>	02/01/2024	\$50.03	\$12.78	\$21.45	\$0.00	\$84.26
	08/01/2024	\$51.53	\$12.78	\$21.45	\$0.00	\$85.76
	02/01/2025	\$52.78	\$12.78	\$21.45	\$0.00	\$87.01
	08/01/2025	\$54.28	\$12.78	\$21.45	\$0.00	\$88.51
	02/01/2026	\$55.53	\$12.78	\$21.45	\$0.00	\$89.76

Apprentice - ROOFER - Local 33

Effective Date - 02/01/2024

Step	percent	Apprentice Base Wage	Health	Pension	Supplemental Unemployment	Total Rate
1	50	\$25.02	\$12.78	\$6.21	\$0.00	\$44.01
2	60	\$30.02	\$12.78	\$21.45	\$0.00	\$64.25
3	65	\$32.52	\$12.78	\$21.45	\$0.00	\$66.75
4	75	\$37.52	\$12.78	\$21.45	\$0.00	\$71.75
5	85	\$42.53	\$12.78	\$21.45	\$0.00	\$76.76

Effective Date - 08/01/2024

Step	percent	Apprentice Base Wage	Health	Pension	Supplemental Unemployment	Total Rate
1	50	\$25.77	\$12.78	\$6.21	\$0.00	\$44.76
2	60	\$30.92	\$12.78	\$21.45	\$0.00	\$65.15
3	65	\$33.49	\$12.78	\$21.45	\$0.00	\$67.72
4	75	\$38.65	\$12.78	\$21.45	\$0.00	\$72.88
5	85	\$43.80	\$12.78	\$21.45	\$0.00	\$78.03

Notes: ** 1:5, 2:6-10, the 1:10; Reroofing: 1:4, then 1:1
 Step 1 is 2000 hrs.; Steps 2-5 are 1000 hrs.
 (Hot Pitch Mechanics' receive \$1.00 hr. above ROOFER)

Apprentice to Journeyworker Ratio:**

ROOFER SLATE / TILE / PRECAST CONCRETE <i>ROOFERS LOCAL 33</i>	02/01/2024	\$50.28	\$12.78	\$21.45	\$0.00	\$84.51
	08/01/2024	\$51.78	\$12.78	\$21.45	\$0.00	\$86.01
	02/01/2025	\$53.03	\$12.78	\$21.45	\$0.00	\$87.26
	08/01/2025	\$54.53	\$12.78	\$21.45	\$0.00	\$88.76
	02/01/2026	\$55.78	\$12.78	\$21.45	\$0.00	\$90.01

For apprentice rates see "Apprentice- ROOFER"

SHEETMETAL WORKER <i>SHEETMETAL WORKERS LOCAL 17 - A</i>	02/01/2024	\$57.22	\$14.59	\$27.50	\$2.98	\$102.29
	08/01/2024	\$58.97	\$14.59	\$27.50	\$2.98	\$104.04
	02/01/2025	\$60.72	\$14.59	\$27.50	\$2.98	\$105.79
	08/01/2025	\$62.57	\$14.59	\$27.50	\$2.98	\$107.64
	02/01/2026	\$64.52	\$14.59	\$27.50	\$2.98	\$109.59

Apprentice - SHEET METAL WORKER - Local 17-A

Effective Date - 02/01/2024

Step	percent	Apprentice Base Wage	Health	Pension	Supplemental Unemployment	Total Rate
1	42	\$24.03	\$14.59	\$6.13	\$0.00	\$44.75
2	42	\$24.03	\$14.59	\$6.13	\$0.00	\$44.75
3	47	\$26.89	\$14.59	\$12.11	\$1.61	\$55.20
4	47	\$26.89	\$14.59	\$12.11	\$1.61	\$55.20
5	52	\$29.75	\$14.59	\$13.09	\$1.72	\$59.15
6	52	\$29.75	\$14.59	\$13.34	\$1.73	\$59.41
7	60	\$34.33	\$14.59	\$14.75	\$1.91	\$65.58
8	65	\$37.19	\$14.59	\$15.73	\$2.03	\$69.54
9	75	\$42.92	\$14.59	\$17.69	\$2.26	\$77.46
10	85	\$48.64	\$14.59	\$19.15	\$2.47	\$84.85

Effective Date - 08/01/2024

Step	percent	Apprentice Base Wage	Health	Pension	Supplemental Unemployment	Total Rate
1	42	\$24.77	\$14.59	\$6.13	\$0.00	\$45.49
2	42	\$24.77	\$14.59	\$6.13	\$0.00	\$45.49
3	47	\$27.72	\$14.59	\$12.11	\$1.63	\$56.05
4	47	\$27.72	\$14.59	\$12.11	\$1.63	\$56.05
5	52	\$30.66	\$14.59	\$13.09	\$1.75	\$60.09
6	52	\$30.66	\$14.59	\$13.34	\$1.76	\$60.35
7	60	\$35.38	\$14.59	\$14.75	\$1.94	\$66.66
8	65	\$38.33	\$14.59	\$15.73	\$2.06	\$70.71
9	75	\$44.23	\$14.59	\$17.69	\$2.30	\$78.81
10	85	\$50.12	\$14.59	\$19.15	\$2.52	\$86.38

Notes:
Steps are 6 mos.

Apprentice to Journeyworker Ratio:1:4

SPECIALIZED EARTH MOVING EQUIP < 35 TONS TEAMSTERS JOINT COUNCIL NO. 10 ZONE B	01/01/2024	\$39.24	\$15.07	\$18.67	\$0.00	\$72.98
	06/01/2024	\$40.24	\$15.07	\$18.67	\$0.00	\$73.98
	12/01/2024	\$40.24	\$15.07	\$20.17	\$0.00	\$75.48
	01/01/2025	\$40.24	\$15.57	\$20.17	\$0.00	\$75.98
	06/01/2025	\$41.24	\$15.57	\$20.17	\$0.00	\$76.98
	12/01/2025	\$41.24	\$15.57	\$21.78	\$0.00	\$78.59
	01/01/2026	\$41.24	\$16.17	\$21.78	\$0.00	\$79.19
	06/01/2026	\$42.24	\$16.17	\$21.78	\$0.00	\$80.19
	12/01/2026	\$42.24	\$16.17	\$23.52	\$0.00	\$81.93
	01/01/2027	\$42.24	\$16.77	\$23.52	\$0.00	\$82.53

Classification	Effective Date	Base Wage	Health	Pension	Supplemental Unemployment	Total Rate
SPECIALIZED EARTH MOVING EQUIP > 35 TONS <i>TEAMSTERS JOINT COUNCIL NO. 10 ZONE B</i>	01/01/2024	\$39.53	\$15.07	\$18.67	\$0.00	\$73.27
	06/01/2024	\$40.53	\$15.07	\$18.67	\$0.00	\$74.27
	12/01/2024	\$40.53	\$15.07	\$20.17	\$0.00	\$75.77
	01/01/2025	\$40.53	\$15.57	\$20.17	\$0.00	\$76.27
	06/01/2025	\$41.53	\$15.57	\$20.17	\$0.00	\$77.27
	12/01/2025	\$41.53	\$15.57	\$21.78	\$0.00	\$78.88
	01/01/2026	\$41.53	\$16.17	\$21.78	\$0.00	\$79.48
	06/01/2026	\$42.53	\$16.17	\$21.78	\$0.00	\$80.48
	12/01/2026	\$42.53	\$16.17	\$23.52	\$0.00	\$82.22
	01/01/2027	\$42.53	\$16.77	\$23.52	\$0.00	\$82.82
SPRINKLER FITTER <i>SPRINKLER FITTERS LOCAL 550 - (Section A) Zone 1</i>	10/01/2023	\$67.95	\$10.90	\$23.20	\$0.00	\$102.05
	03/01/2024	\$69.75	\$10.90	\$23.20	\$0.00	\$103.85
	10/01/2024	\$71.55	\$10.90	\$23.20	\$0.00	\$105.65
	03/01/2025	\$73.35	\$10.90	\$23.20	\$0.00	\$107.45

Classification

Effective Date Base Wage Health Pension Supplemental Unemployment Total Rate

Apprentice - SPRINKLER FITTER - Local 550 (Section A) Zone 1

Effective Date - 10/01/2023

Step	percent	Apprentice Base Wage	Health	Pension	Supplemental Unemployment	Total Rate
1	35	\$23.78	\$10.90	\$12.80	\$0.00	\$47.48
2	40	\$27.18	\$10.90	\$13.60	\$0.00	\$51.68
3	45	\$30.58	\$10.90	\$14.40	\$0.00	\$55.88
4	50	\$33.98	\$10.90	\$15.20	\$0.00	\$60.08
5	55	\$37.37	\$10.90	\$16.00	\$0.00	\$64.27
6	60	\$40.77	\$10.90	\$16.80	\$0.00	\$68.47
7	65	\$44.17	\$10.90	\$17.60	\$0.00	\$72.67
8	70	\$47.57	\$10.90	\$18.40	\$0.00	\$76.87
9	75	\$50.96	\$10.90	\$19.20	\$0.00	\$81.06
10	80	\$54.36	\$10.90	\$20.00	\$0.00	\$85.26

Effective Date - 03/01/2024

Step	percent	Apprentice Base Wage	Health	Pension	Supplemental Unemployment	Total Rate
1	35	\$24.41	\$10.90	\$12.80	\$0.00	\$48.11
2	40	\$27.90	\$10.90	\$13.60	\$0.00	\$52.40
3	45	\$31.39	\$10.90	\$14.40	\$0.00	\$56.69
4	50	\$34.88	\$10.90	\$15.20	\$0.00	\$60.98
5	55	\$38.36	\$10.90	\$16.00	\$0.00	\$65.26
6	60	\$41.85	\$10.90	\$16.80	\$0.00	\$69.55
7	65	\$45.34	\$10.90	\$17.60	\$0.00	\$73.84
8	70	\$48.83	\$10.90	\$18.40	\$0.00	\$78.13
9	75	\$52.31	\$10.90	\$19.20	\$0.00	\$82.41
10	80	\$55.80	\$10.90	\$20.00	\$0.00	\$86.70

Notes: Apprentice entered prior 9/30/10:
40/45/50/55/60/65/70/75/80/85
Steps are 850 hours

Apprentice to Journeyworker Ratio:1:3

STEAM BOILER OPERATOR	12/01/2023	\$54.43	\$15.00	\$16.40	\$0.00	\$85.83
OPERATING ENGINEERS LOCAL 4	06/01/2024	\$55.71	\$15.00	\$16.40	\$0.00	\$87.11
	12/01/2024	\$57.15	\$15.00	\$16.40	\$0.00	\$88.55
	06/01/2025	\$58.43	\$15.00	\$16.40	\$0.00	\$89.83
	12/01/2025	\$59.87	\$15.00	\$16.40	\$0.00	\$91.27
	06/01/2026	\$61.15	\$15.00	\$16.40	\$0.00	\$92.55
	12/01/2026	\$62.59	\$15.00	\$16.40	\$0.00	\$93.99

For apprentice rates see "Apprentice- OPERATING ENGINEERS"

Classification	Effective Date	Base Wage	Health	Pension	Supplemental Unemployment	Total Rate
TAMPERS, SELF-PROPELLED OR TRACTOR DRAWN <i>OPERATING ENGINEERS LOCAL 4</i>	12/01/2023	\$54.43	\$15.00	\$16.40	\$0.00	\$85.83
	06/01/2024	\$55.71	\$15.00	\$16.40	\$0.00	\$87.11
	12/01/2024	\$57.15	\$15.00	\$16.40	\$0.00	\$88.55
	06/01/2025	\$58.43	\$15.00	\$16.40	\$0.00	\$89.83
	12/01/2025	\$59.87	\$15.00	\$16.40	\$0.00	\$91.27
	06/01/2026	\$61.15	\$15.00	\$16.40	\$0.00	\$92.55
	12/01/2026	\$62.59	\$15.00	\$16.40	\$0.00	\$93.99

For apprentice rates see "Apprentice- OPERATING ENGINEERS"

TERRAZZO FINISHERS <i>BRICKLAYERS LOCAL 3 - MARBLE & TILE</i>	02/01/2024	\$61.34	\$11.49	\$23.59	\$0.00	\$96.42
	08/01/2024	\$63.44	\$11.49	\$23.59	\$0.00	\$98.52
	02/01/2025	\$64.74	\$11.49	\$23.59	\$0.00	\$99.82
	08/01/2025	\$66.89	\$11.49	\$23.59	\$0.00	\$101.97
	02/01/2026	\$68.24	\$11.49	\$23.59	\$0.00	\$103.32
	08/01/2026	\$70.44	\$11.49	\$23.59	\$0.00	\$105.52
	02/01/2027	\$71.84	\$11.49	\$23.59	\$0.00	\$106.92

Apprentice - TERRAZZO FINISHER - Local 3 Marble & Tile

Effective Date - 02/01/2024

Step	percent	Apprentice Base Wage	Health	Pension	Supplemental Unemployment	Total Rate
1	50	\$30.67	\$11.49	\$23.59	\$0.00	\$65.75
2	60	\$36.80	\$11.49	\$23.59	\$0.00	\$71.88
3	70	\$42.94	\$11.49	\$23.59	\$0.00	\$78.02
4	80	\$49.07	\$11.49	\$23.59	\$0.00	\$84.15
5	90	\$55.21	\$11.49	\$23.59	\$0.00	\$90.29

Effective Date - 08/01/2024

Step	percent	Apprentice Base Wage	Health	Pension	Supplemental Unemployment	Total Rate
1	50	\$31.72	\$11.49	\$23.59	\$0.00	\$66.80
2	60	\$38.06	\$11.49	\$23.59	\$0.00	\$73.14
3	70	\$44.41	\$11.49	\$23.59	\$0.00	\$79.49
4	80	\$50.75	\$11.49	\$23.59	\$0.00	\$85.83
5	90	\$57.10	\$11.49	\$23.59	\$0.00	\$92.18

Notes:

Apprentice to Journeyworker Ratio:1:3

TEST BORING DRILLER <i>LABORERS - FOUNDATION AND MARINE</i>	12/01/2023	\$48.33	\$9.65	\$18.22	\$0.00	\$76.20
	06/01/2024	\$49.81	\$9.65	\$18.22	\$0.00	\$77.68
	12/01/2024	\$51.28	\$9.65	\$18.22	\$0.00	\$79.15
	06/01/2025	\$52.78	\$9.65	\$18.22	\$0.00	\$80.65
	12/01/2025	\$54.28	\$9.65	\$18.22	\$0.00	\$82.15
	06/01/2026	\$55.83	\$9.65	\$18.22	\$0.00	\$83.70
	12/01/2026	\$57.33	\$9.65	\$18.22	\$0.00	\$85.20

For apprentice rates see "Apprentice- LABORER"

Classification	Effective Date	Base Wage	Health	Pension	Supplemental Unemployment	Total Rate
TEST BORING DRILLER HELPER <i>LABORERS - FOUNDATION AND MARINE</i>	12/01/2023	\$44.45	\$9.65	\$18.22	\$0.00	\$72.32
	06/01/2024	\$45.93	\$9.65	\$18.22	\$0.00	\$73.80
	12/01/2024	\$47.40	\$9.65	\$18.22	\$0.00	\$75.27
	06/01/2025	\$48.90	\$9.65	\$18.22	\$0.00	\$76.77
	12/01/2025	\$50.40	\$9.65	\$18.22	\$0.00	\$78.27
	06/01/2026	\$51.95	\$9.65	\$18.22	\$0.00	\$79.82
	12/01/2026	\$53.45	\$9.65	\$18.22	\$0.00	\$81.32
For apprentice rates see "Apprentice- LABORER"						
TEST BORING LABORER <i>LABORERS - FOUNDATION AND MARINE</i>	12/01/2023	\$44.33	\$9.65	\$18.22	\$0.00	\$72.20
	06/01/2024	\$45.81	\$9.65	\$18.22	\$0.00	\$73.68
	12/01/2024	\$47.28	\$9.65	\$18.22	\$0.00	\$75.15
	06/01/2025	\$48.78	\$9.65	\$18.22	\$0.00	\$76.65
	12/01/2025	\$50.28	\$9.65	\$18.22	\$0.00	\$78.15
	06/01/2026	\$51.83	\$9.65	\$18.22	\$0.00	\$79.70
	12/01/2026	\$53.33	\$9.65	\$18.22	\$0.00	\$81.20
For apprentice rates see "Apprentice- LABORER"						
TRACTORS/PORTABLE STEAM GENERATORS <i>OPERATING ENGINEERS LOCAL 4</i>	12/01/2023	\$54.43	\$15.00	\$16.40	\$0.00	\$85.83
	06/01/2024	\$55.71	\$15.00	\$16.40	\$0.00	\$87.11
	12/01/2024	\$57.15	\$15.00	\$16.40	\$0.00	\$88.55
	06/01/2025	\$58.43	\$15.00	\$16.40	\$0.00	\$89.83
	12/01/2025	\$59.87	\$15.00	\$16.40	\$0.00	\$91.27
	06/01/2026	\$61.15	\$15.00	\$16.40	\$0.00	\$92.55
	12/01/2026	\$62.59	\$15.00	\$16.40	\$0.00	\$93.99
For apprentice rates see "Apprentice- OPERATING ENGINEERS"						
TRAILERS FOR EARTH MOVING EQUIPMENT <i>TEAMSTERS JOINT COUNCIL NO. 10 ZONE B</i>	01/01/2024	\$39.82	\$15.07	\$18.67	\$0.00	\$73.56
	06/01/2024	\$40.82	\$15.07	\$18.67	\$0.00	\$74.56
	12/01/2024	\$40.82	\$15.07	\$20.17	\$0.00	\$76.06
	01/01/2025	\$40.82	\$15.57	\$20.17	\$0.00	\$76.56
	06/01/2025	\$41.82	\$15.57	\$20.17	\$0.00	\$77.56
	12/01/2025	\$41.82	\$15.57	\$21.78	\$0.00	\$79.17
	01/01/2026	\$41.82	\$16.17	\$21.78	\$0.00	\$79.77
	06/01/2026	\$42.82	\$16.17	\$21.78	\$0.00	\$80.77
	12/01/2026	\$42.82	\$16.17	\$23.52	\$0.00	\$82.51
01/01/2027	\$42.82	\$16.77	\$23.52	\$0.00	\$83.11	
TUNNEL WORK - COMPRESSED AIR <i>LABORERS (COMPRESSED AIR)</i>	12/01/2023	\$56.56	\$9.65	\$18.67	\$0.00	\$84.88
	06/01/2024	\$58.04	\$9.65	\$18.67	\$0.00	\$86.36
	12/01/2024	\$59.51	\$9.65	\$18.67	\$0.00	\$87.83
	06/01/2025	\$61.01	\$9.65	\$18.67	\$0.00	\$89.33
	12/01/2025	\$62.51	\$9.65	\$18.67	\$0.00	\$90.83
	06/01/2026	\$64.06	\$9.65	\$18.67	\$0.00	\$92.38
	12/01/2026	\$65.56	\$9.65	\$18.67	\$0.00	\$93.88
For apprentice rates see "Apprentice- LABORER"						

Classification	Effective Date	Base Wage	Health	Pension	Supplemental Unemployment	Total Rate
TUNNEL WORK - COMPRESSED AIR (HAZ. WASTE) <i>LABORERS (COMPRESSED AIR)</i>	12/01/2023	\$58.56	\$9.65	\$18.67	\$0.00	\$86.88
	06/01/2024	\$60.04	\$9.65	\$18.67	\$0.00	\$88.36
	12/01/2024	\$61.51	\$9.65	\$18.67	\$0.00	\$89.83
	06/01/2025	\$63.01	\$9.65	\$18.67	\$0.00	\$91.33
	12/01/2025	\$64.51	\$9.65	\$18.67	\$0.00	\$92.83
	06/01/2026	\$66.06	\$9.65	\$18.67	\$0.00	\$94.38
	12/01/2026	\$67.56	\$9.65	\$18.67	\$0.00	\$95.88
For apprentice rates see "Apprentice- LABORER"						
TUNNEL WORK - FREE AIR <i>LABORERS (FREE AIR TUNNEL)</i>	12/01/2023	\$48.63	\$9.65	\$18.67	\$0.00	\$76.95
	06/01/2024	\$50.11	\$9.65	\$18.67	\$0.00	\$78.43
	12/01/2024	\$51.58	\$9.65	\$18.67	\$0.00	\$79.90
	06/01/2025	\$53.08	\$9.65	\$18.67	\$0.00	\$81.40
	12/01/2025	\$54.58	\$9.65	\$18.67	\$0.00	\$82.90
	06/01/2026	\$56.13	\$9.65	\$18.67	\$0.00	\$84.45
	12/01/2026	\$57.63	\$9.65	\$18.67	\$0.00	\$85.95
For apprentice rates see "Apprentice- LABORER"						
TUNNEL WORK - FREE AIR (HAZ. WASTE) <i>LABORERS (FREE AIR TUNNEL)</i>	12/01/2023	\$50.63	\$9.65	\$18.67	\$0.00	\$78.95
	06/01/2024	\$52.11	\$9.65	\$18.67	\$0.00	\$80.43
	12/01/2024	\$53.58	\$9.65	\$18.67	\$0.00	\$81.90
	06/01/2025	\$55.08	\$9.65	\$18.67	\$0.00	\$83.40
	12/01/2025	\$56.58	\$9.65	\$18.67	\$0.00	\$84.90
	06/01/2026	\$58.13	\$9.65	\$18.67	\$0.00	\$86.45
	12/01/2026	\$59.63	\$9.65	\$18.67	\$0.00	\$87.95
For apprentice rates see "Apprentice- LABORER"						
VAC-HAUL <i>TEAMSTERS JOINT COUNCIL NO. 10 ZONE B</i>	01/01/2024	\$39.24	\$15.07	\$18.67	\$0.00	\$72.98
	06/01/2024	\$40.24	\$15.07	\$18.67	\$0.00	\$73.98
	12/01/2024	\$40.24	\$15.07	\$20.17	\$0.00	\$75.48
	01/01/2025	\$40.24	\$15.57	\$20.17	\$0.00	\$75.98
	06/01/2025	\$41.24	\$15.57	\$20.17	\$0.00	\$76.98
	12/01/2025	\$41.24	\$15.57	\$21.78	\$0.00	\$78.59
	01/01/2026	\$41.24	\$16.17	\$21.78	\$0.00	\$79.19
	06/01/2026	\$42.24	\$16.17	\$21.78	\$0.00	\$80.19
	12/01/2026	\$42.24	\$16.17	\$23.52	\$0.00	\$81.93
01/01/2027	\$42.24	\$16.77	\$23.52	\$0.00	\$82.53	
VOICE-DATA-VIDEO TECHNICIAN <i>ELECTRICIANS LOCAL 96</i>	09/03/2023	\$34.49	\$13.00	\$17.22	\$0.00	\$64.71
	09/01/2024	\$35.29	\$13.99	\$17.57	\$0.00	\$66.85
	09/07/2025	\$36.12	\$14.98	\$17.91	\$0.00	\$69.01
	09/06/2026	\$37.04	\$15.96	\$18.27	\$0.00	\$71.27

Classification

Effective Date Base Wage Health Pension Supplemental Unemployment Total Rate

Apprentice - VOICE-DATA-VIDEO TECHNICIAN - Local 96

Effective Date - 09/03/2023

Step	percent	Apprentice Base Wage	Health	Pension	Supplemental Unemployment	Total Rate
1	50	\$17.25	\$13.00	\$4.31	\$0.00	\$34.56
2	55	\$18.97	\$13.00	\$4.36	\$0.00	\$36.33
3	60	\$20.69	\$13.00	\$16.81	\$0.00	\$50.50
4	65	\$22.42	\$13.00	\$16.86	\$0.00	\$52.28
5	70	\$24.14	\$13.00	\$16.91	\$0.00	\$54.05
6	75	\$25.87	\$13.00	\$16.97	\$0.00	\$55.84
7	80	\$27.59	\$13.00	\$17.02	\$0.00	\$57.61
8	85	\$29.32	\$13.00	\$17.07	\$0.00	\$59.39

Effective Date - 09/01/2024

Step	percent	Apprentice Base Wage	Health	Pension	Supplemental Unemployment	Total Rate
1	50	\$17.65	\$13.99	\$4.41	\$0.00	\$36.05
2	55	\$19.41	\$13.99	\$4.46	\$0.00	\$37.86
3	60	\$21.17	\$13.99	\$17.15	\$0.00	\$52.31
4	65	\$22.94	\$13.99	\$17.20	\$0.00	\$54.13
5	70	\$24.70	\$13.99	\$17.25	\$0.00	\$55.94
6	75	\$26.47	\$13.99	\$17.30	\$0.00	\$57.76
7	80	\$28.23	\$13.99	\$17.36	\$0.00	\$59.58
8	85	\$30.00	\$13.99	\$17.41	\$0.00	\$61.40

Notes:

Apprentice to Journeyworker Ratio:1:1

WAGON DRILL OPERATOR LABORERS - ZONE 2	12/01/2023	\$38.11	\$9.65	\$17.14	\$0.00	\$64.90
---	------------	---------	--------	---------	--------	---------

For apprentice rates see "Apprentice- LABORER"

WAGON DRILL OPERATOR (HEAVY & HIGHWAY) LABORERS - ZONE 2 (HEAVY & HIGHWAY)	12/01/2023	\$38.11	\$9.65	\$17.14	\$0.00	\$64.90
	06/01/2024	\$39.44	\$9.65	\$17.14	\$0.00	\$66.23
	12/01/2024	\$40.77	\$9.65	\$17.14	\$0.00	\$67.56
	06/01/2025	\$42.16	\$9.65	\$17.14	\$0.00	\$68.95
	12/01/2025	\$43.54	\$9.65	\$17.14	\$0.00	\$70.33
	06/01/2026	\$44.98	\$9.65	\$17.14	\$0.00	\$71.77
	12/01/2026	\$46.42	\$9.65	\$17.14	\$0.00	\$73.21

For apprentice rates see "Apprentice- LABORER (Heavy and Highway)"

WASTE WATER PUMP OPERATOR OPERATING ENGINEERS LOCAL 4	12/01/2023	\$55.03	\$15.00	\$16.40	\$0.00	\$86.43
	06/01/2024	\$56.33	\$15.00	\$16.40	\$0.00	\$87.73
	12/01/2024	\$57.78	\$15.00	\$16.40	\$0.00	\$89.18
	06/01/2025	\$59.08	\$15.00	\$16.40	\$0.00	\$90.48
	12/01/2025	\$60.53	\$15.00	\$16.40	\$0.00	\$91.93
	06/01/2026	\$61.83	\$15.00	\$16.40	\$0.00	\$93.23
	12/01/2026	\$63.28	\$15.00	\$16.40	\$0.00	\$94.68

Classification	Effective Date	Base Wage	Health	Pension	Supplemental Unemployment	Total Rate
For apprentice rates see "Apprentice- OPERATING ENGINEERS"						
WATER METER INSTALLER	09/03/2023	\$66.44	\$14.07	\$18.86	\$0.00	\$99.37
PLUMBERS & GASFITTERS LOCAL 12	03/03/2024	\$68.24	\$14.07	\$18.86	\$0.00	\$101.17
	09/01/2024	\$70.04	\$14.07	\$18.86	\$0.00	\$102.97
	03/02/2025	\$71.34	\$14.32	\$19.11	\$0.00	\$104.77
For apprentice rates see "Apprentice- PLUMBER/PIPEFITTER" or "PLUMBER/GASFITTER"						

Additional Apprentice Information:

Minimum wage rates for apprentices employed on public works projects are listed above as a percentage of the pre-determined hourly wage rate established by the Commissioner under the provisions of the M.G.L. c. 149, ss. 26-27D. Apprentice ratios are established by the Division of Apprenticeship Training pursuant to M.G.L. c. 23, ss. 11E-11L.

All apprentices must be registered with the Division of Apprenticeship Training in accordance with M.G.L. c. 23, ss. 11E-11L.

All steps are six months (1000 hours.)

Ratios are expressed in allowable number of apprentices to journeymen or fraction thereof, unless otherwise specified.

** Multiple ratios are listed in the comment field.

*** APP to JM; 1:1, 2:2, 2:3, 3:4, 4:4, 4:5, 4:6, 5:7, 6:7, 6:8, 6:9, 7:10, 8:10, 8:11, 8:12, 9:13, 10:13, 10:14, etc.

**** APP to JM; 1:1, 1:2, 2:3, 2:4, 3:5, 4:6, 4:7, 5:8, 6:9, 6:10, 7:11, 8:12, 8:13, 9:14, 10:15, 10:16, etc.

AGREEMENT

This AGREEMENT, made this DAY OF _____, 2024 by and between the Town of Hudson, Massachusetts hereinafter called "OWNER" and _____ doing business as a corporation, hereinafter called "CONTRACTOR" by its duly authorized officer (s).

WITNESSETH: that for and in consideration of the payments and agreements hereinafter mentioned:

1. The CONTRACTOR will commence and complete the work of MILLING & OVERLAY OF VARIOUS ROADS (A) in the Town of Hudson in a timely and workmanlike manner according to normal accepted standards of the trade.
2. The CONTRACTOR will furnish all materials, supplies, tools, equipment, labor and other service necessary for the professional construction and completion of the PROJECT described herein, other than the items furnished by the OWNER.
3. The CONTRACTOR will commence the work required by the CONTRACT DOCUMENT within ten (10) calendar days after a date to be stated in the NOTICE TO PROCEED and shall complete the work by **7/1/2024**, using not more than 90 consecutive calendar days unless the time for completion is extended otherwise by the CONTRACT DOCUMENTS.
4. The CONTRACTOR agrees to perform all of the work described in the CONTRACT DOCUMENTS and comply with the terms therein for the sums show on the BID SCHEDULE.
5. The term "CONTRACT DOCUMENTS" means and includes the following:
 - (A) Advertisement for Bids
 - (B) Information for Bidders
 - (C) Special Conditions-In General
Special Conditions-Commonwealth of Massachusetts
Special Conditions-Equal Employment Opportunity
Prevailing Wage rates
 - (D) Agreement
 - (E) Bid Bond
 - (F) Master Bid item list
Bid Proposal
 - (G) Payment Bond
 - (H) Performance Bond
 - (I) Certificate of Authority
 - (J) Notice to Proceed
 - (K) General Conditions
 - (L) Notice of Award
 - (M) Change Order
 - (N) Addenda No. _____
 - (O) Work Items
 - (P) Appendix
 - (Q) Tax compliance
 - (R) Project A -Estimated Scope
6. The OWNER will pay to the CONTRACTOR in the manner and at such times as set forth in the General Conditions such amounts as required by the CONTRACT DOCUMENTS.
7. The Agreement shall be binding upon all parties hereto and their respective heirs, executors, administrators, successors and assigns.

IN WITNESS WHEREOF, the parties hereto have executed, or caused to be executed by their duly authorized officials, this Agreement in six copies, each of which shall be deemed an original on the date first above written.

TOWN OF HUDSON, MASSACHUSETTS

BY: BOARD OF SELECTMEN

(SEAL)

ATTEST:

NAME

TITLE

CONTRACTOR

(SEAL)

ADDRESS

ATTEST:

CITY

AUTHORIZED SIGNATURE

NAME

NAME (PLEASE PRINT)

TITLE

TITLE

In accordance with the Commonwealth of Massachusetts General Laws Chapter 44, Section 31C, I certify that an appropriation has been voted and is available in the amount of this contract and that the Executive Assistant is authorized under Article 4, Section 3 of the Town Charter to execute this contract and all requisitions and change orders.

DIRECTOR OF FINANCE

APPROPRIATION CODE

BID BOND

KNOW ALL MEN BY THESE PRESENTS, that we the undersigned,

_____ as Principal and

_____ as surety, are hereby held

and firmly bound unto _____ as OWNER in the penal

sum of _____ for the payment of which, well and

truly to be made, we hereby jointly and severally bind ourselves, successors and assigns.

Signed this _____ day of _____ 2024.

The Condition of the above obligation is such that whereas the Principal has submitted to

_____ a certain BID, attached hereto and

hereby made a part hereof to enter into a contract in writing, for the _____

NOW, THEREFORE,

- (A) If said BID shall be rejected, or
- (B) If said BID shall be accepted and the Principal shall execute and deliver a contract in the Form of Contract attached hereto (properly completed in accordance with said BID) and shall furnish a BOND for his faithful performance of said contract, and for the payment of all persons performing labor or furnishing materials in connection therewith, and shall in all other respects perform the agreement created by the acceptance of said BID.

Then this obligation shall be void, otherwise the same shall remain in force and effect; it being expressly understood and agreed that the liability of the Surety for any and all claims hereunder shall, in no event, exceed the penal amount of this obligation as herein stated.

The surety, for value received, hereby stipulates and agrees that the obligations of said Surety and its BOND shall be in no way impaired or affected by any extension of the time within which the OWNER may accept such bid; and said Surety does hereby waive notice of any such extension.

IN WITNESS WHEREOF, the Principal and the Surety have hereunto set their hands and seals and such of them as are corporations have caused their corporate seals to be hereto affixed and these presents to be signed by their proper officers, the day year first set forth above.

PRINCIPAL

SURETY

BY:

IMPORTANT - Surety companies executing BONDS must appear on the Treasury Department's most current list (Circular 570 as amended) and be authorized to transact business in the state where the project is located.

BID ITEMS FOR PROJECT A

MILLING & OVERLAY OF MISCELLANEOUS ROADS

Bidder agrees to perform all the work, including all incidental labor, materials and equipment for the satisfactory completion of the work in full compliance with the contents and intent of the specification and/or plans of the work, for the following prices:

PROJECT A

ITEM NO.	QUAN.	DESCRIPTION UNIT PRICE IN WORDS	UNIT PRICE IN FIGURES	EXTENDED TOTAL IN FIGURES
129.00	18,590 SY	MILLING - ASPHALT EXCAVATION BY COLD PLANING (ENTIRE ROAD WIDTH)		
		_____ DOLLARS		
		_____ CENTS PER SY	\$ _____ PER SY	\$ _____
222.00	12 EA	MANHOLE/CATCH BASIN FRAME AND GRATE (OR COVER)		
		_____ DOLLARS		
		_____ CENTS PER EA	\$ _____ PER EA	\$ _____
223.10	43 EA	FRAME AND GRATES (OR COVERS) REMOVED AND RESET		
		_____ DOLLARS		
		_____ CENTS PER EA	\$ _____ PER EA	\$ _____

ITEM NO.	QUAN.	DESCRIPTION UNIT PRICE IN WORDS	UNIT PRICE IN FIGURES	EXTENDED TOTAL IN FIGURES
354.00	21 EA	GATE BOX REMOVE & RESET (AND/OR USE OF RINGS)		
		_____ DOLLARS		
		_____ CENTS PER EA	\$ _____ PER EA	\$ _____
357.00	8 EA	GATE BOX		
		_____ DOLLARS		
		_____ CENTS PER EA	\$ _____ PER EA	\$ _____
440.00	500 LB	CALCIUM CHLORIDE FOR ROADWAY DUST CONTROL		
		_____ DOLLARS		
		_____ CENTS PER LB	\$ _____ PER LB	\$ _____
460.00	1,573 TN	CLASS I BITUMINOUS CONCRETE TYPE I-1		
		_____ DOLLARS		
		_____ CENTS PER TN	\$ _____ PER TN	\$ _____

ITEM NO.	QUAN.	DESCRIPTION UNIT PRICE IN WORDS	UNIT PRICE IN FIGURES	EXTENDED TOTAL IN FIGURES
851.00	1 LS	SAFETY SIGNING-CONST. OPERATIONS		
		_____ DOLLARS		
		_____ CENTS PER LS	\$ _____ PER LS	\$ _____
860.04	100 LF	4" WHITE REFLECTOR PAINT		
		_____ DOLLARS		
		_____ CENTS PER LF	\$ _____ PER LF	\$ _____
860.12	400 LF	12" WHITE REFLECTOR PAINT		
		_____ DOLLARS		
		_____ CENTS PER LF	\$ _____ PER LF	\$ _____
861.041	2,540 LF	4" SINGLE YELLOW REFLECTOR PAINT		
		_____ DOLLARS		
		_____ CENTS PER LF	\$ _____ PER LF	\$ _____
861.042	2,540 LF	4" DOUBLE YELLOW REFLECTOR PAINT		
		_____ DOLLARS		
		_____ CENTS PER LF	\$ _____ PER LF	\$ _____

TOTAL BID PRICE - PROJECT A

_____ DOLLARS AND

_____ CENTS

\$ _____

COMPANY _____

ADDRESS _____

TELEPHONE NO. _____

DATE _____

BY _____

PLEASE PRINT

TITLE _____

PLEASE PRINT

SIGNATURE

BID PROPOSAL

PROPOSAL OF: _____
(Hereinafter called "BIDDER"), organized and existing under the laws of the State of _____
_____ doing business as _____
(a corporation, or a partnership, or an individual).

TO: THE BOARD OF SELECTMEN FOR THE TOWN OF HUDSON, MASSACHUSETTS
(hereinafter the Town of Hudson shall be called "OWNER").

In compliance with your Advertisement for Bids, BIDDER hereby proposed to perform all WORK for the **MILLING & OVERLAY OF VARIOUS ROADS PROJECT (A) IN HUDSON**, in strict accordance with the CONTRACT DOCUMENTS, within the time set forth therein and at the prices stated below.

BIDDER hereby agrees to commence work under this contract within 10 consecutive calendar days after a date to be specified in the NOTICE TO PROCEED and fully complete the project within consecutive calendar days thereafter unless the time for completion is extended otherwise by the Contract Documents. Work performed beyond this CONTRACT TIME PERIOD (completions) will be subject to liquidated damages. BIDDER further agrees to pay as liquidated damages, the sum of \$750.00 for each consecutive calendar day thereafter as provided in Article 15 of the General Conditions.

The BIDDER agrees not to withdraw his bid within 60 days after the actual date of bid opening.

BIDDER acknowledges receipt of ADDENDA NO. _____ through _____.

The BIDDER agrees that, if he is selected as general contractor, he will within ten (10) days after presentation thereof by the awarding authority, execute a contract in accordance with the terms of this general bid and furnish a performance bond and a payment bond, each of a surety company qualified to do business under the laws of the State of Massachusetts and satisfactory to the awarding authority. Each bond shall be in the sum of one hundred percent of the contract price, the premiums for which are to be paid by the general contractor and are included in the contract price.

The bid price shall include all profit, overhead, costs and expenses, labor, materials, bailing, shoring, removal and insurance.

BIDDER understands that the OWNER reserves the right to reject any or all bids and waive any informalities in the bidding.

The undersigned represents that this proposal is made, in good faith without fraud, collusion or connection of any kind with any bidder for the same work; that he is competing in his own interests and in his own behalf without connection or obligation to any undisclosed person; that no other person has any interest in the profits of the contract; that he has informed himself fully in regard to all conditions pertaining to the work and in regard to the place where it is to be done; and that he has made his own examination and estimates from which this proposal is made.

The BIDDER further agrees that the bid deposit left with the Awarding Authority shall become and be the property of the Town of Hudson as liquidated damages if, after an award is made to him, he shall fail to enter into the contract therefore within ten (10) business days after notice of said award has been mailed or delivered to him.

The undersigned hereby certifies that he is able to furnish labor that can work in harmony with all other elements of labor employed or to be employed in the work.

The BIDDER is a (n) _____
(A.) Individual (B.) Partnership or (C.) Corporation

Complete applicable section below:

A. Individual OWNER

State full name and address of OWNER. If business is carried on in any name other than that of the OWNER, state such name and address:

B. Partnership

C. Corporation

Corporation is incorporated in the State of _____.

President is _____.

Treasurer is _____.

If there are any principals other than those identified above, state the full names and addresses of each (specify officers and majority stockholders if a corporation, general partners if a partnership).

Place of business in Massachusetts is _____.

If the BIDDER is a Foreign Corporation, also state the following:

(1) The Power of Attorney required by General Laws, Chapter 181, Section 3, was filed on:

_____.

(2) The Certificate and copy of its Charter, Articles or Certificate of Incorporation required by General Laws, Chapter 181, Section 5, were filed on _____.

If the business is conducted under any title other than the real name of the owner, state the time when and place where, the Certificate required by General Laws, Chapter 110, Section 5, was filed:

The Federal Social Security Identification Number of the BIDDER (the number used on employer's quarterly Federal Tax return, U.S. Treasury Department Form 941) is

If the BIDDER is an individual doing business under a name other than his own name the proposal must so state, giving the address of the individual.

If the BIDDER is a partnership the Proposal must so state, setting forth the names and addresses of all partners, and must be signed by a partner designated as such.

If the BIDDER is a Corporation, the Proposal must be signed by a duly authorized Officer or Agent of such Corporation.

The Town shall not enter into a Contract with a BIDDER which is a Foreign Corporation until such Foreign Corporation has filed with the Awarding Authority a Certificate of the State Secretary for the Commonwealth stating that such Corporation has complied with General Laws, Chapter 181, Sections 3 and 5 and the date of such compliance.

Have you ever defaulted on a contract? If so, where and why?

List the more important contracts recently completed by you, stating the approximate cost for each, the month and year completed and indicated which are similar to the work called for under this Contract.

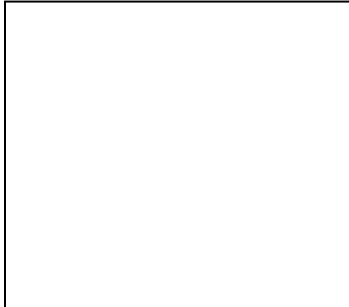

(Seal if Bid is by a Corporation)

Respectfully submitted:

By _____
(Signature of Bidder)

Title _____

PAYMENT BOND

KNOW ALL MEN BY THESE PRESENTS:

THAT

NAME OF CONTRACTOR

ADDRESS OF CONTRACTOR

A _____, hereinafter called Principal, and
(Corporation, Partnership or Individual)

NAME OF OWNER

ADDRESS OF OWNER

hereinafter called OWNER, in the penal sum of _____-Dollars,

(\$ _____) in lawful money of the United States, for the payment of which sum will and truly to be made, we bind ourselves, successors and assigns, jointly and severally, firmly by these presents.

THE CONDITION OF THIS OBLIGATIONS is such that whereas, the Principal entered into a certain contract with the OWNER, dated the _____ day of _____ 2024, a copy of which is hereto attached and made a part hereof for the construction of:

NOW, THEREFORE, if the Principal shall promptly make payment to all persons, firms, SUBCONTRACTORS, and corporations furnishing materials for or performing labor in the prosecution of the WORK provided for in such contract, and any authorized extension or modification thereof, including all amounts due for materials, lubricants, oil, gasoline, coal and coke, repairs on machinery, equipment and tools, consumed or used in connection wit the construction of such WORK, and all insurance premiums on said WORK, and for all labor, performed in such WORK whether by SUBCONTRACTOR or otherwise, then this obligation shall be void; otherwise to remain in full force and effect

PROVIDED, FURTHER, that the said Surety for value received hereby stipulates and agrees that not change, extension of time, alteration or addition to the terms of the contract or to the WORK to be performed thereunder or the SPECIFICATIONS accompanying the same shall in anywise affect its obligation on this BOND, and it does hereby waive notice of any such change, extension of time, alteration or addition to the terms of the contract or to the WORK or to the SPECIFICATIONS.

PROVIDED, FURTHER, that no final settlement between the OWNER and the CONTRACTOR shall abridge the right of any beneficiary hereunder, whose claim may be unsatisfied.

IN WITNESS WHEREOF, this instrument is executed in _____ counterparts, each one of which shall be deemed an original, this the _____ day of _____ 2024.

ATTEST:

PRINCIPAL

PRINCIPAL SECRETARY

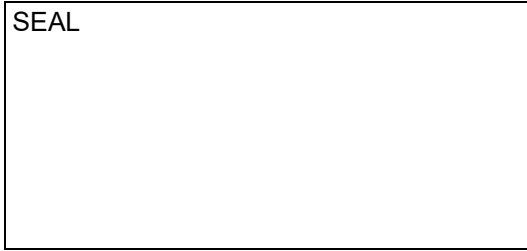

BY _____

ADDRESS

WITNESS AS TO PRINCIPAL

ADDRESS

SURETY

ATTEST:

BY: _____
ATTORNEY-AT-FACT

WITNESS AS TO SURETY

ADDRESS

NOTE: Date of BOND must not be prior to date of Contract.

If CONTRACTOR is Partnership, all partners should execute BOND.

IMPORTANT: Surety companies executing BONDS must appear on the Treasury Department's most current list (Circular 570 as amended) and be authorized to transact business in the State where the PROJECT is located.

ATTEST:

PRINCIPAL

BY _____

PRINCIPAL SECRETARY

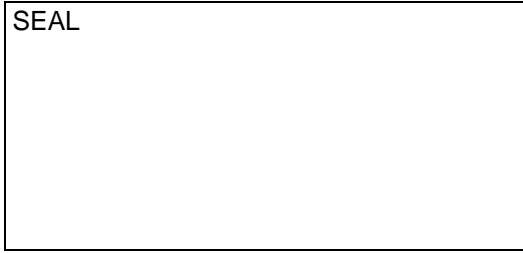
SEAL

ADDRESS

WITNESS AS TO PRINCIPAL

ADDRESS

SURETY

ATTEST:

SURETY SECRETARY

WITNESS AS TO SURETY

ADDRESS

SEAL

BY: _____

ATTORNEY-IN-FACT

ADDRESS

NOTE: Date of BOND must not be prior to date of Contract. If CONTRACTOR is Partnership, all partners should execute BOND.

IMPORTANT: Surety companies executing BONDS must appear on the Treasury Department's most current list (Circular 570 as amended) and be authorized to transact business in the state where the PROJECT is located.

CERTIFICATE OF AUTHORITY
MEETING OF BOARD OF DIRECTORS

At a meeting of the Directors of the McIver Brothers duly called and held at _____ on the _____ day of _____, 2024 at which a quorum was present and acting, it was voted, that _____ the _____ of this Corporation is hereby authorized and empowered to make, enter into, sign, seal and deliver, on behalf of this Corporation a Contract for the MILLING AND OVERLAY OF VARIOUS STREETS PROJECT (A) with the Town of Hudson, and performance and payment bonds (each in the full amount of the Contract) in connection with such Contract.

I do hereby certify that the above is a true and correct copy of the record, that said vote has not been amended or repealed and is in full force and effect as of this date, and that _____ is duly elected _____ of this Corporation.

Clerk or Secretary of the Corporation

NOTICE TO PROCEED

TO:

PROJECT DESCRIPTION:

MILLING & OVERLAY OF VARIOUS ROADS PROJECT (A) IN HUDSON.

You are hereby notified to commence WORK in accordance with the Agreement dated _____ you are to complete the WORK within 90 consecutive calendar days thereafter. The date of completion of all WORK is therefore _____

OWNER: **TOWN OF HUDSON**

BY:

ERIC M RYDER
DIRECTOR OF PUBLIC WORKS

ACCEPTANCE OF NOTICE

Receipt of the above NOTICE TO PROCEED is hereby acknowledged by:

_____ this the _____ day of
_____, 20_____.

BY: _____ TITLE: _____

GENERAL CONDITIONS

1. DEFINITIONS	K- 2
2. ADDITIONAL INSTRUCTIONS AND DETAIL DRAWINGS	K- 3
3. SCHEDULES, REPORTS AND RECORDS	K- 3
4. DRAWINGS AND SPECIFICATIONS	K- 4
5. SHOP DRAWINGS	K- 4
6. MATERIALS, SERVICES AND FACILITIES	K- 6
7. INSPECTION AND TESTING	K- 6
8. SUBSTITUTIONS	K- 7
9. PATENTS	K- 8
10. SURVEYS, PERMITS, REGULATIONS	K- 8
11. PROTECTION OF WORK, PROPERTY, PERSONS	K- 8
12. SUPERVISION BY CONTRACTOR	K- 9
13. CHANGES IN THE WORK	K- 9
14. CHANGES IN CONTRACT PRICE	K- 9
15. TIME FOR COMPLETION AND LIQUIDATED DAMAGES	K- 9
16. CORRECTION OF WORK	K-10
17. SUBSURFACE CONDITIONS	K-10
18. SUSPENSION OF WORK, TERMINATION AND DELAY	K-10
19. PAYMENTS TO CONTRACTOR	K-11
20. ACCEPTANCE OF FINAL PAYMENT AS RELEASE	K-12
21. INSURANCE	K-12
22. CONTRACT SECURITY	K-14
23. ASSIGNMENTS	K-14
24. INDEMNIFICATION	K-14
25. SEPARATE CONTRACTS	K-14
26. SUBCONTRACTING	K-15
27. ENGINEER'S AUTHORITY	K-15
28. LAND AND RIGHTS OF WAY	K-15
29. GUARANTY	K-16
30. ARBITRATION	K-16
31. TAXES	K-16
32. ADDITIONAL PROVISIONS	K-16
33. LIMITATIONS OF DATA PRESENTED	K-17
34. ADDENDA AND INTERPRETATIONS`	K-17

1. DEFINITIONS

- 1.1 Wherever used in the CONTRACT DOCUMENTS, the following terms shall have the meanings indicated which shall be applicable to both the singular and plural thereof.
- 1.2 ADDENDA - Written or graphic instruments issued prior to the execution of the Agreement which modify or interpret the CONTRACT DOCUMENTS, DRAWINGS and SPECIFICATIONS, by additions, deletions, clarifications or corrections.
- 1.3 BID - The offer or proposal of the BIDDER submitted on the prescribed form setting forth the prices for the WORK TO BE PERFORMED.
- 1.4 BIDDER - Any person, firm or corporation submitting a BID for the WORK.
- 1.5 BONDS - Bid, Performance, and Payment Bonds and other instruments of security, furnished by the Contractor and his surety in accordance with the CONTRACT DOCUMENTS.
- 1.6 CHANGE ORDER - A written order to the CONTRACTOR authorizing an addition, deletion or revision in the WORK within the general scope of the CONTRACT DOCUMENTS, or authorizing an adjustment in the CONTRACT PRICE or CONTRACT TIME.
- 1.7 CONTRACT DOCUMENTS - The contract, including Advertisement For Bids, Information for Bidders, BID, Bid Bond, Agreement, Payment Bond, Performance Bond, NOTICE OF AWARD, NOTICE TO PROCEED, CHANGE ORDER, DRAWINGS, SPECIFICATIONS and ADDENDA.
- 1.8 CONTRACT PRICE - The total monies payable to the CONTRACTOR under the terms and conditions of the CONTRACT DOCUMENTS.
- 1.9 CONTRACT TIME - The number of calendar days stated in the CONTRACT DOCUMENTS for the completion of the WORK.
- 1.10 CONTRACTOR - The person, firm or corporation with whom the OWNER has executed the Agreement.
- 1.11 DRAWINGS - The part of the CONTRACT DOCUMENTS which show the characteristics and scope of the WORK to be performed and which have been prepared or approved by the ENGINEER.
- 1.12 ENGINEER - The person, firm or corporation named as such in the CONTRACT DOCUMENTS.
- 1.13 FIELD ORDER - A written order effecting a change in the WORK not involving an adjustment in the CONTRACT PRICE or an extension of the CONTRACT TIME, issued by the ENGINEER to the CONTRACTOR during construction.
- 1.14 NOTICE OF AWARD - The written notice of the acceptance of the BID from the OWNER to the successful BIDDER.
- 1.15 NOTICE TO PROCEED - Written communication issued by the OWNER to the CONTRACTOR authorizing him to proceed with the WORK and establishing the date of commencement of the WORK.
- 1.16 OWNER - A public or quasi-public body or authority, corporation, association, partnership, or individual for whom the work is to be performed.
- 1.17 PROJECT - The undertaking to be performed as provided in the CONTRACT DOCUMENTS.
- 1.18 RESIDENT PROJECT REPRESENTATIVE - The authorized representative of the OWNER who is assigned to the PROJECT site or any part thereof.
- 1.19 SHOP DRAWINGS - All drawings, diagrams, illustrations, brochures, schedules and other data which are prepared by the CONTRACTOR, a SUBCONTRACTOR, manufacturer, SUPPLIER or distributor, which illustrate how specific portions of the WORK shall be fabricated or, installed.
- 1.20 SPECIFICATIONS - A part of the CONTRACT DOCUMENTS consisting of written descriptions of a technical nature of materials, equipment, construction systems, standards and workmanship.
- 1.21 SUBCONTRACTOR - An individual, firm or corporation having a direct contract with the CONTRACTOR or with any other SUBCONTRACTOR for the performance of a part of the work at the site.
- 1.22 SUBSTANTIAL COMPLETION - That date as certified by the ENGINEER when the construction of the PROJECT or a specified part thereof is sufficiently completed, in accordance with the CONTRACT DOCUMENTS, so that the PROJECT or specified part can be utilized for the purposes for which it is intended.

- 1.23 SUPPLEMENTAL GENERAL CONDITIONS - Modifications to General Conditions required by a Federal Agency for participation in the PROJECT and approved by the agency in writing prior to inclusion in the CONTRACT DOCUMENTS, or such requirements that may be imposed by applicable state laws.
- 1.24 SUPPLIER - Any person or organization who supplies materials or equipment for the WORK, including that fabricated to a special design, but who does not perform labor at the site.
- 1.25 WORK - All labor necessary to produce the construction required by the CONTRACT DOCUMENTS, and all materials and equipment incorporated or to be incorporated in the PROJECT.
- 1.26 WRITTEN NOTICE - Any notice to any party of the Agreement relative to any part of this Agreement in writing and considered delivered and the service thereof completed, when posted by certified or registered mail to the said party at his last given address, or delivered in person to said party or his authorized representative on the WORK.
- 1.27 The words "Awarding Authority" or pronoun in place of it shall mean the authorized agent or representative of the OWNER as defined herein for which the project shall be undertaken.
- 1.28 The word "State" shall mean the State or Commonwealth in which the WORK under this CONTRACT is to be performed.
- 1.29 Whenever the works "as directed", "as permitted", "as required", or words of like effect are used, it shall be understood that the direction, permission or requirements of the Engineer is intended, and similarly the works "approved", "acceptable", "satisfactory", or words of like import shall mean approved or acceptable or satisfactory to the ENGINEER.
- 1.30 Whenever the words "or equal" or words of like import are used, it shall be understood that this means equal in accordance with the following provisions; an item shall be considered equal, if in the opinion of the ENGINEER; (1) it is at least equal in quality, durability, appearance, strength, and design; (2) it will perform at least equally the function imposed by the general design for the public work being contracted for or the materials being purchased; and (3) it conform substantially even with deviations, to the detailed requirements for the item.
- 1.31 Whenever any power is possessed by, or act or thing is to be done by the OWNER under this CONTRACT, the exercise of such power or the doing of such act or thing by the Awarding Authority shall be a sufficient compliance with the terms of this CONTRACT unless by law some other officer of the OWNER is required to act in the premises.
- 1.32 Both the address given in the BID upon which this CONTRACT is founded and the CONTRACTOR'S office at or near the site of the work are hereby designated as places to either of which notices, letters and any other communications to the CONTRACTOR shall be certified, mailed or delivered. The delivering to the above-named place, or depositing in a post-paid wrapper directed to the first named place, in any post office box regularly maintained by the Post Office Department, or any notice letter or other communications to the CONTRACTOR, shall be deemed sufficient service thereof upon the CONTRACTOR, and the date of said service shall be the date of such delivery or mailing. The first named address may be changed at any time by an instrument in writing, executed and acknowledged by the CONTRACTOR and delivered to the ENGINEER. Nothing herein contained shall be deemed to preclude or render inoperative the service of any notice, letter or communication upon CONTRACTOR personally.

2. ADDITIONAL INSTRUCTIONS AND DETAIL DRAWINGS

- 2.1 The CONTRACTOR may be furnished additional instructions and detail drawings, by the ENGINEER, as necessary to carry out the WORK required by the CONTRACT DOCUMENTS.
- 2.2 The additional drawings and instruction thus supplied will become a part of the CONTRACT DOCUMENTS. The CONTRACTOR shall carry out the WORK in accordance with the additional detail drawings and instructions.

3. SCHEDULES, REPORTS AND RECORDS

- 3.1 Within ten (10) days after the WORK has commences, the CONTRACTOR shall submit to the ENGINEER for approval a progress schedule in satisfactory form, showing in detail his proposed progress for the construction of the various parts of the WORK and the proposed times for receiving the various materials required. He shall, at the end of each month or more often if required, furnish the ENGINEER two copies of a chart showing actual progress of the various parts of the work in comparison with the originally proposed progress schedule as approved.
- 3.2 See 3.1
- 3.3 The CONTRACTOR shall also submit a schedule of payments that he anticipates he will earn during the course of the WORK.
- 3.4 The WORK is to commence within ten (10) days of a date to be specified in the NOTICE TO PROCEED. WORK shall continue with dispatch to completion and no suspension of work will be allowed without approval of the ENGINEER.
- 3.5 No Saturday, Sunday, holiday or work days longer than eight hours requiring the presence of the ENGINEER, an inspector, or observer will be permitted, without prior arrangements with the ENGINEER, except in the case of an emergency, and then only to the extent that is absolutely necessary, and, if practical, with the written permission of the ENGINEER. If Saturday, Sunday, holiday or work days longer than eight hours are contemplated, the CONTRACTOR shall notify the ENGINEER not later than Friday or the previous week to allow arrangements to be made for inspection. If the CONTRACTOR must work beyond the regular work week in order to complete the project within the contract time, all expenses of the ENGINEER and his personnel required for inspection or observation will be deducted monthly from any sums due or which will become due to the CONTRACTOR.
- 3.6 Prior to commencing any work at the site requiring the presence of the ENGINEER or his representative, the CONTRACTOR shall notify the ENGINEER or his representative, the CONTRACTOR shall notify the ENGINEER in writing at least 24 hours in advance of the exact date and time on which he intends to start the work.

In the event that the CONTRACTOR fails to meet this schedule, the ENGINEER'S on site time will be assessed to the CONTRACTOR and will be deducted from any sums due or which will become due the CONTRACTOR.

4. DRAWINGS AND SPECIFICATIONS

- 4.1 The intent of the DRAWINGS and SPECIFICATIONS is that the CONTRACTOR shall furnish all labor, materials, tools, equipment, and transportation necessary for the proper execution of the WORK in accordance with the CONTRACT DOCUMENTS and all incidental work necessary to complete the PROJECT in an acceptable manner, ready for use, occupancy or operation by the OWNER.
It is agreed that the Advertisement, Information for Bidders, Special Conditions, Accepted Proposal, Drawings, Specifications and the Addenda and Interpretations heretofore issued are a part of this CONTRACT. Any WORK shown on the drawings, though not mentioned in the CONTRACT or SPECIFICATIONS, and any work mentioned in the CONTRACT or SPECIFICATIONS, though not shown on the DRAWINGS, is to be executed by the CONTRACTOR as a part of this CONTRACT.
- 4.2 In case of conflict between the DRAWINGS and SPECIFICATIONS, the SPECIFICATIONS shall govern. Figure dimensions on DRAWINGS shall govern over scale dimensions, and detailed DRAWINGS shall govern over general DRAWINGS.
- 4.3 Any discrepancies found between the DRAWINGS and SPECIFICATIONS shall be immediately reported to the ENGINEER, in writing, who shall promptly correct such inconsistencies or ambiguities in writing. WORK done by the CONTRACTOR after his discovery of such discrepancies, inconsistencies or ambiguities shall be done at the CONTRACTOR'S risk.

5. SHOP DRAWINGS

- 5.1 The CONTRACTOR shall provide SHOP DRAWINGS as may be necessary for the prosecution of the WORK as required by the CONTRACT DOCUMENTS. The ENGINEER shall promptly review all SHOP DRAWINGS. The ENGINEER'S approval of any SHOP DRAWING shall not release the CONTRACTOR from responsibility for deviations from the CONTRACT DOCUMENTS. The approval of any SHOP DRAWING which substantially deviates from the requirement of the CONTRACT DOCUMENTS shall be evidence by a CHANGE ORDER.
- 5.2 When submitted for the ENGINEER'S review SHOP DRAWINGS shall bear the CONTRACTOR'S certification that he has reviewed, checked and approved the SHOP DRAWINGS and that they are in conformance with the requirements of the CONTRACT DOCUMENTS.
- 5.3 Portions of the WORK requiring a SHOP DRAWING or sample submission shall not begin until the SHOP DRAWING or submission has been approved by the ENGINEER. A copy of each approved SHOP DRAWING and each approved sample shall be kept in good order by the CONTRACTOR at the site and shall be available to the ENGINEER.
- 5.4 The CONTRACTOR shall submit to the ENGINEER, before any shop work is commenced, eight prints or one reproducible and four prints of shop drawings for all items stated in the SPECIFICATIONS as requiring SHOP DRAWINGS. Additional prints for regulatory agencies shall be submitted when indicated in the SPECIFICATIONS. Standard forms for processing SHOP DRAWINGS will be furnished to the CONTRACTOR, by the ENGINEER.
 - 5.4.1 No SHOP DRAWINGS shall be submitted directly by SUBCONTRACTORS or SUPPLIERS. All SHOP DRAWINGS shall be submitted through the GENERAL CONTRACTOR who shall check and verify all field dimensions, check for compliance with the CONTRACT DOCUMENTS, stamp and endorse all drawings to indicate his approval and compliance with the above, and assign a transmittal number to each submission. Numbers shall be assigned in sequence. In the event that a SHOP DRAWING is returned marked "Amend and Resubmit" or "Rejected" subsequent resubmittals for the same item shall retain the same transmittal number, but shall have an alphabetical suffix (3a, 3b, etc.). With each submission, the CONTRACTOR shall, in writing, call the ENGINEER'S attention to any deviations from the CONTRACT DOCUMENTS and the additional costs, if any, caused by these deviations.
 - 5.4.2 No portion of the work requiring a SHOP DRAWING shall be commenced until the SHOP DRAWING has been reviewed by the ENGINEER. If the first submittal of the SHOP DRAWINGS is marked either "No Exceptions Taken" or "Make Corrections Noted" four prints or the reproducible only will be returned to the CONTRACTOR and fabrication of the item may begin. If the SHOP DRAWINGS are marked "Amend and Resubmit" or "Rejected", two prints or the reproducible only will be returned to the CONTRACTOR with notation thereon of correction required. The CONTRACTOR shall cause the necessary corrections to be made and shall resubmit eight prints or one reproducible and four prints with transmittal number and letters as defined above. If subsequent resubmittals are still not acceptable, resubmittals shall be made under the procedure outlined above until final acceptance is received.
 - 5.4.3 The ENGINEER will review SHOP DRAWINGS with reasonable promptness, but his review shall be only for conformance with the design concept of the PROJECT and for compliance with the information given in the CONTRACT DOCUMENTS. The acceptance of the separate item as such will not indicate acceptance of the assembly in which the item functions. The CONTRACTOR shall make any corrections required by the ENGINEER and shall return the required number of corrected copies. The CONTRACTOR shall make any corrections required by the ENGINEER and shall return the required number of corrected copies. The CONTRACTOR shall direct specific attention in writing or on resubmitted SHOP DRAWINGS to revision other than the corrections called for by the ENGINEER on the previous submission.

- 5.4.4 The ENGINEER'S review of SHOP DRAWINGS shall not relieve the CONTRACTOR from his responsibility from any deviations from the requirements of the CONTRACT DOCUMENTS unless the CONTRACTOR has in writing called the ENGINEER'S attention to such deviations at the time of submission and the ENGINEER has given written acceptance to the specific deviation, nor shall any acceptance by the ENGINEER relieve the CONTRACTOR from responsibility for errors or omissions in the SHOP DRAWINGS. The final acceptance of SHOP DRAWINGS by the ENGINEER shall not operate to relieve the CONTRACTOR in any way of his responsibility under this contract for the satisfactory completion of the work, or for the accuracy of the dimensions, details, quantities or for their agreement. No change shall be made in the accepted SHOP DRAWINGS without written consent of the ENGINEER. The CONTRACT PRICE shall include the cost of furnishing all SHOP DRAWINGS and the CONTRACTOR shall be allowed no extra compensation therefor.
- 5.5 The CONTRACTOR shall submit to the ENGINEER for review, with such promptness as to cause no delay in the work, all samples required by the CONTRACT DOCUMENTS. All samples shall be checked by and stamped with the approval of the CONTRACTOR, identified clearly as to material, manufacturer, any pertinent catalog number, the use for which intended, and the section number and paragraph of the specification wherein the material is specified. All samples shall be shipped post and/or freight paid. Standard forms for processing samples will be furnished to the CONTRACTOR by the ENGINEER.
- 5.5.1 At the time of each submission, the CONTRACTOR shall in writing, call the ENGINEER'S attention to any deviations that the samples may have the requirement of the CONTRACT DOCUMENTS.
- 5.5.2 The ENGINEER will review with reasonable promptness submitted samples, but his review shall be only for conformance with the information given in the CONTRACT DOCUMENTS. The acceptance of a separate item as such will not indicate acceptance of the assembly in which the item functions. In the event samples are not accepted, the CONTRACTOR shall resubmit new samples until acceptance is obtained.
- 5.5.3 No work requiring sample submission shall be commenced until the submission has been accepted by the ENGINEER.
- 5.5.4 The ENGINEER'S acceptance of sample shall not relieve the CONTRACTOR from his responsibility for any deviations from the requirements of the CONTRACT DOCUMENTS unless the CONTRACTOR has in writing called the ENGINEER'S attention to such deviation at the time of submission and the ENGINEER has given written acceptance of the specific deviations.

6. MATERIALS, SERVICES AND FACILITIES

- 6.1 It is understood that except as otherwise specifically stated in the CONTRACT DOCUMENTS, the CONTRACTOR shall provide and pay for all materials, labor, tools, equipment, water, light, power, transportation, supervision, temporary construction of any nature whatsoever necessary to execute, complete, and deliver the WORK within the specified time.
- 6.2 Materials and equipment shall be so stored as to insure the preservation of their quality and fitness for the WORK. Stored materials and equipment to be incorporated in the WORK shall be located so as to facilitate prompt inspection.
- 6.3 Manufactured articles, materials and equipment shall be applied, installed, connected, erected, used, cleaned and conditioned as directed by the manufacturer.
- 6.4 Materials, supplies and equipment shall be in accordance with samples submitted by the CONTRACTOR and approved by the ENGINEER.
- 6.5 Materials, supplies, or equipment to be incorporated into the WORK shall not be purchased by the CONTRACTOR subject to a chattel mortgage or under a conditional sale contract or other agreement by which an interest is retained by the seller.

- 6.6 All materials are to be new, unused and the best and of finest quality of their several kinds. The CONTRACTOR shall provide facilities and handle all materials as required for the inspection by the ENGINEER. Materials which have been rejected by the ENGINEER shall be removed from the site of the WORK together with all surplus earth and materials which in the opinion of the ENGINEER are unsuitable or not in conformity with the CONTRACT DOCUMENTS. Disposal of materials shall be without expense to the OWNER. The CONTRACTOR shall promptly replace any materials rejected or condemned, and shall not be allowed extra time for completion of the WORK by reason of such rejection.

7. INSPECTION AND TESTING

- 7.1 All materials and equipment used in the construction of the PROJECT shall be subject to adequate inspection and testing in accordance with generally accepted standards, as required and defined in the CONTRACT DOCUMENTS.
- 7.1 The OWNER shall provide all inspection and testing services not required by the CONTRACT DOCUMENTS.
- 7.2 The CONTRACTOR shall provide at his expense the testing and inspection services required by the CONTRACT DOCUMENTS.
- 7.3 If the CONTRACT DOCUMENTS, laws, ordinances, rules, regulations or orders of any public authority having jurisdiction require any WORK to specifically be inspected, tested, or approved by someone other than the CONTRACTOR, the CONTRACTOR will give the ENGINEER timely notice of readiness. The CONTRACTOR will then furnish the ENGINEER the required certificates of inspection, testing or approval.
- 7.4 Inspections, tests or approvals by the ENGINEER or others shall not relieve the CONTRACTOR from his obligations to perform the WORK in accordance with the requirements of the CONTRACT DOCUMENTS.

Should inspections or tests reveal defective work, the defective work shall be made good and unsuitable materials shall be rejected, notwithstanding that such work and materials have been previously overlooked and accepted or estimated for payment. If the work or any part thereof shall be found defective at any time before the final acceptance of the whole work, the CONTRACTOR shall forthwith make good such defect in a manner satisfactory to the ENGINEER. Nothing in this CONTRACT shall forthwith make good such defect in a manner satisfactory to the ENGINEER. Nothing in this CONTRACT shall be construed as vesting in the CONTRACTOR any right or property in the materials used after they have been attached or affixed to the work or the soil but all such materials shall, upon being so attached or fixed, become the property of the OWNER.

All portions of the work condemned by the ENGINEER as failing to conform to the CONTRACT PLANS or specifications PLANS or SPECIFICATIONS shall be taken down and removed and the CONTRACTOR shall promptly replace and re-execute the same in accordance therewith and without expense to the OWNER, and bear the expense of making good all work or property of other contractors or of the OWNER destroyed or damaged by such removal or replacement.

- 7.6 The ENGINEER and his representatives will at all times have access to the WORK. In addition, authorized representatives and agents of any participating Federal or State agency shall be permitted to inspect all work, materials, payrolls, records of personnel, invoices of materials, and other relevant data and records. The CONTRACTOR will provide proper facilities for such access and observation of the WORK and also for any inspection, or testing thereof.
- 7.7 If any WORK is covered contrary to the written instructions of the ENGINEER it must, if requested by the ENGINEER, be uncovered for his observation and replaced at the CONTRACTOR'S EXPENSE.
- 7.8 If the ENGINEER considers it necessary or advisable that covered WORK be inspected or tested by others, the CONTRACTOR, at the ENGINEER'S request, will uncover, expose or otherwise make available for observation, inspection or testing as the ENGINEER may require, that portion of the WORK in question, furnishing all necessary labor, materials, tools, and equipment. If it is found that such expenses of such uncovering, exposure, observation, inspection and testing and of satisfactory reconstruction. If, however, such WORK is not found to be defective, the CONTRACTOR will be allowed an increase in the CONTRACT PRICE or an extension of the CONTRACT TIME, or both, directly attributable to such uncovering, exposure, observation, inspection, testing and reconstruction and an appropriate CHANGE ORDER shall be issued.

8. SUBSTITUTIONS

- 8.1 Whenever a material, article or piece of equipment is identified on the DRAWINGS or SPECIFICATIONS by reference to brand name or catalogue number, it shall be understood that this is referenced for the purpose of defining the performance or other salient requirements and that other products of equal capacities, quality and functions shall be of a material, article, or piece of equipment of equal substance and function for those referred to in the CONTRACT DOCUMENTS by reference to brand name or catalogue material, article, or piece of equipment is of equal substance and function to that specified, the ENGINEER may approve its substitution and use by the CONTRACTOR. Any cost differential shall be deductible from the CONTRACT PRICE and the CONTRACT DOCUMENTS shall be appropriately modified by CHANGE ORDER. The CONTRACTOR warrants that if substitutes are approved, no major changes in the function or general design of the PROJECT will result. Incidental changes or extra component parts required to accommodate the substitute will be made by the CONTRACTOR without a change in the CONTRACT PRICE or CONTRACT TIME.

Whenever it is written that an equipment manufacturer must have a specified period of experience with his products, equipment which does not meet the experience period can be considered if the equipment supplier or manufacturer is willing to provide a bond or cash deposit for the duration of the specified time period which will guarantee replacement of that equipment in the event of failure.

9. PATENTS

- 9.1 The CONTRACTOR shall pay all applicable royalties and license fees. He shall defend all suits or claims for infringement of any patent rights and save the OWNER harmless from loss on account thereof, except that the OWNER shall be responsible for any such loss when a particular process, design, or the product of a particular manufacturer or manufacturers is specified, however if the CONTRACTOR has reason to believe that the design, process or product specified is an infringement of a patent, he shall be responsible for such loss unless he promptly gives such information to the ENGINEER.

10. SURVEYS, PERMITS, REGULATIONS

- 10.1 The OWNER shall furnish all boundary surveys and establish all base lines for locating the principal component parts of the WORK together with a suitable number of bench marks adjacent to the WORK as shown in the CONTRACT DOCUMENTS. From the information provided by the OWNER, unless otherwise specified in the CONTRACT DOCUMENTS, the CONTRACTOR shall develop and make all detail surveys needed for construction such as slope stakes, batter boards, stakes for pile locations and other working points, lines, elevations and cut sheets.

The CONTRACTOR shall employ, at his expense, a competent surveyor, registered in the state wherein the WORK is to be done to perform such duties.

- 10.2 The CONTRACTOR shall carefully preserve bench marks, reference points and stakes and, in case of willful or careless destruction, he shall be charged with the resulting expense and shall be responsible for any mistakes that may be caused by their unnecessary loss or disturbance.
- 10.3 Permits and licenses of a temporary nature necessary for the prosecution of the WORK shall be secured and paid for by the CONTRACTOR unless otherwise stated in the SUPPLEMENTAL GENERAL CONDITIONS. Permits, and easements for permanent structures or permanent changes in existing facilities shall be secured and paid for by the OWNER, unless otherwise specified. The CONTRACTOR shall give all notices and comply with all laws, ordinances, rules and regulations bearing on the conduct of the WORK as drawn and specified. If the CONTRACTOR observes that the CONTRACT DOCUMENTS are at variance therewith, he shall promptly notify the ENGINEER in writing, and any necessary changes shall be adjusted as provided in Section 13, CHANGES IN THE WORK.

11. PROTECTION OF WORK, PROPERTY AND PERSONS

- 11.1 The CONTRACTOR will be responsible for initiating, maintaining and supervising all safety precautions and programs in connection with the WORK. He will take all necessary precautions for the safety of, and will provide the necessary protection to prevent damage, injury or loss to all employees on the WORK and other persons who may be affected thereby, all the WORK and all materials or equipment to be incorporated therein, whether in storage on or off the site, and other property at the site or adjacent thereto, including trees, shrubs, lawns, walks, pavements, roadways, structures and utilities not designated for removal, relocation or replacement in the course of construction.

The CONTRACTOR shall be responsible for and pay for all loss or damage to materials and property, whether such are incorporated in, or to be incorporated in the work. The CONTRACTOR shall also replace or restore to original condition man-made or natural improvement, or other thing injured or interfered with by the CONTRACTOR in carrying on the CONTRACT.

- 11.2 The CONTRACTOR will comply with all applicable laws, ordinances, rules, regulations and orders of any public body having jurisdiction. He will erect and maintain, as required by the conditions and progress of the WORK, all necessary safeguards for safety and protection. He will notify owners of adjacent utilities when prosecution of the WORK may affect them. The CONTRACTOR will remedy all damage, injury or loss to any property caused, directly or indirectly, in whole or in part, by the CONTRACTOR, any SUBCONTRACTOR or anyone directly or indirectly employed by any of them or anyone whose acts any of them be liable, except damage or loss attributable to the fault of the CONTRACT DOCUMENTS or to the acts of omissions of the OWNER or the ENGINEER or anyone employed by either of them or anyone for whose acts either of them may be liable, and not attributable, directly or indirectly, in whole or in part, to the fault or negligence of the CONTRACTOR.
- 11.3 In emergencies affecting the safety of persons or the WORK or property at the site or adjacent thereto, the CONTRACTOR, without special instruction or authorization from the ENGINEER or OWNER, shall act to prevent threatened damage, injury or loss. He will give the ENGINEER prompt WRITTEN NOTICE or any significant changes in the WORK or deviations from the CONTRACT DOCUMENTS caused thereby, and a CHANGE ORDER shall thereupon be issued covering the changes and deviations involved.

12. SUPERVISION BY CONTRACTOR

- 12.1 The CONTRACTOR will supervise and direct the WORK. He will be solely responsible for the means, methods, techniques, sequences and procedures of construction. The CONTRACTOR will employ and maintain on the WORK a qualified supervisor or superintendent who shall have been designated in writing by the CONTRACTOR as the CONTRACTOR'S representative at the site. The supervisor shall have full authority to act on behalf of the CONTRACTOR and all communications given to the supervisor shall be as binding as if given to the CONTRACTOR. The supervisor shall be present on the site at all times as required to perform adequate supervision and coordination of the WORK.
- 12.2 The CONTRACTOR shall employ only competent workers and, whenever the ENGINEER shall notify the CONTRACTOR, in writing, that any person on the WORK is, in his opinion, incompetent, unfaithful, disorderly or otherwise unsatisfactory or not employed in accordance with the provisions of this CONTRACT, such person shall be discharged from the WORK and shall not again be employed on it except with the consent of the ENGINEER.

13. CHANGES IN THE WORK

- 13.1 The OWNER may at any time, as the need arises, order changes within the scope of the WORK without invalidating the AGREEMENT. The Town has the rights and options to omit, eliminate, decrease, or increase any items without the need to change the ranking of the lowest contractor in the bidding list based on the revised total bid price. If such changes increase or decrease the amount due under the CONTRACT DOCUMENTS, or in the time required for performance of the WORK, an equitable adjustment shall be authorized by CHANGE ORDER.
- 13.2 The ENGINEER, also, may at any time, by issuing a FIELD ORDER, make changes in the details of the WORK so ordered by the ENGINEER unless the CONTRACTOR believes that such FIELD ORDER entitles him to a change in CONTRACT PRICE or TIME, or both, in which event he shall give the ENGINEER WRITTEN NOTICE thereof within seven (7) days after the receipt of the ordered change. Thereafter the CONTRACTOR shall document the basis for the change in CONTRACT PRICE or TIME within thirty (30) days. The CONTRACTOR shall not execute such changes pending the receipt of an executed CHANGE ORDER or further instruction from the OWNER.

14. CHANGES IN CONTRACT PRICE

- 14.1 The actual cost for labor, direct overhead, materials, supplies, equipment and other services necessary to complete the work, computed as follows:
- 14.1.1 The reasonable cost of labor employed directly on the work at prevailing rates of wages.
- 14.1.2 The cost of Workman's Compensation Insurance Federal Social Security and State Unemployment Compensation on (1) at established rates.
- 14.1.3 The reasonable cost of materials incorporated in the work.

- 14.1.4 The reasonable cost at fair market rental rates for equipment employed directly on the work.
- 14.1.5 15% of (1), (2), (3), and (4) for overhead, superintendence and profit. (On subcontract work, this 15% will be allowed only to the subcontractor).
- 14.1.6 An additional 5% of (1), (2), (3), and (4) on work performed by a subcontractor of the CONTRACTOR. This 5% includes overhead, superintendence, profit and bonds.

15. TIME FOR COMPLETION AND LIQUIDATED DAMAGES

- 15.1 The date of beginning and the time for completion of the WORK are essential conditions of the CONTRACT DOCUMENTS and the WORK embraced shall be commenced on a date specified in the NOTICE TO PROCEED.
- 15.2 The CONTRACTOR will proceed with the WORK at such rate of progress to insure full completion within the CONTRACT TIME. It is expressly understood and agreed, by and between the CONTRACTOR and the OWNER, that the CONTRACT TIME for the completion of the WORK described herein is a reasonable time, taking into consideration the average climatic and economic conditions and other factors prevailing in the locality of the WORK.
- 15.3 If the CONTRACTOR shall fail to complete the WORK within the CONTRACT TIME, or extension of time granted by the OWNER, then the CONTRACTOR will pay to the OWNER the amount for liquidated damages as specified in the BID for each calendar day that the CONTRACTOR shall be in default after the time stipulated in the CONTRACT DOCUMENTS.
- 15.4 The CONTRACTOR shall not be charged with liquidated damages or any excess cost when the delay in completion of the WORK is due to the following, and the CONTRACTOR has promptly given WRITTEN NOTICE of such delay to the OWNER or ENGINEER.
 - 15.4.1 To any preference, priority or allocation order duly issued by the OWNER.
 - 15.4.2 To unforeseeable causes beyond the control and without the fault or negligence of the CONTRACTOR, including but not restricted to, acts of God, or of the public enemy, acts of the OWNER, acts of another CONTRACTOR in the performance of a contract with the OWNER, fires, floods, epidemics, quarantine restrictions, strikes, freight embargoes, and abnormal and unforeseeable weather; and
 - 15.4.3 To any delays of SUBCONTRACTORS occasioned by any of the causes specified in paragraphs 15.4.1 and 15.4.2 of this article.

16. CORRECTION OF WORK

- 16.1 The CONTRACTOR shall promptly remove from the premises all WORK rejected by the ENGINEER for failure to comply with the CONTRACT DOCUMENTS, whether incorporated in the construction or not, and the CONTRACTOR shall promptly replace and re-execute the WORK in accordance with the CONTRACT DOCUMENTS and without expense to the OWNER and shall bear the expense of making good all work of other contractors destroyed or damaged by such removal or replacements.
- 16.2 All removal and replacement WORK shall be done at the CONTRACTOR'S expense. If the CONTRACTOR does not take action to remove such rejected WORK within ten (10) days after receipt of WRITTEN NOTICE, the OWNER may remove such WORK and store the materials at the expense of the CONTRACTOR.

17. SUBSURFACE CONDITIONS

- 17.1 The CONTRACTOR shall promptly, and before such conditions are disturbed, except in the event of an emergency, notify the OWNER by WRITTEN NOTICE of:
 - 17.1.1 Subsurface or latent physical conditions at the site differing materially from those indicated in the CONTRACT DOCUMENTS, or
 - 17.1.2 Unknown physical conditions at the site, or an unusual nature, differing materially from those ordinarily encountered and generally recognized as inherent in WORK of the character provided for in the CONTRACT DOCUMENTS.
- 17.2 The OWNER shall promptly investigate the conditions, and if he finds that such conditions do so materially differ and cause an increase or decrease in the cost of, or in the time required for, performance of the WORK, an equitable adjustment shall be made and the CONTRACT DOCUMENTS shall be modified by a CHANGE ORDER. Any claim of the CONTRACTOR for adjustment hereunder shall not be allowed unless he has given the required WRITTEN NOTICE,

provided that the OWNER may, if he determines the facts so justify, consider and adjust any such claims asserted before the date of final payment.

18. SUSPENSION OF WORK, TERMINATION AND DELAY

- 18.1 The OWNER may suspend the WORK or any portion thereof for a period of not more than ninety (90) days or such further time as agreed upon by the CONTRACTOR by WRITTEN NOTICE to the CONTRACTOR and the ENGINEER which notice shall fix the date on which WORK shall be resumed. The CONTRACTOR will be allowed an increase in the CONTRACT PRICE or an extension of the CONTRACT TIME, or both, directly attributable to any suspension.
- 18.2 If the CONTRACTOR is adjudged a bankrupt or insolvent, or if he makes a general assignment for the benefit of his creditors, or if a trustee or receiver is appointed for the CONTRACTOR or for any of his property, or if he files a petition to take advantage of any debtor's act, or to reorganize under the bankruptcy or applicable laws, or if he repeatedly fails to make prompt payments to SUBCONTRACTORS or for labor, materials or equipment or if he disregards laws, ordinances, rules, regulations or orders on any public body having jurisdiction of the WORK or if he disregards the authority of the ENGINEER, or if he otherwise violates any provision of the CONTRACT DOCUMENTS, then the OWNER may, without prejudice to any other right or remedy and after giving the CONTRACTOR and his surety a minimum of ten (10) days from delivery of a WRITTEN NOTICE terminate the services of the CONTRACTOR and take possession of the PROJECT and of all materials, equipment, tools, construction equipment and machinery thereon owned by the CONTRACTOR, and finish the WORK by whatever method he may deem expedient. In such case the CONTRACTOR shall not be entitled to receive any further payment until the WORK is finished. If the unpaid balance of the CONTRACT PRICE exceeds the direct and indirect costs of completing the PROJECT, including compensation for additional professional services, such excess SHALL BE PAID TO THE CONTRACTOR. If such costs exceed such unpaid balance, the CONTRACTOR will pay the difference to the OWNER. Such CONTRACTOR will pay the difference to the OWNER. Such costs incurred by the OWNER will be determined by the ENGINEER and incorporated in a CHANGE ORDER.
- 18.3 Where the CONTRACTOR'S services have been so terminated by the OWNER, said termination shall not affect any right of the OWNER against the CONTRACTOR then existing or which may thereafter accrue. Any retention or payment of monies by the OWNER due the CONTRACTOR will not release the CONTRACTOR from compliance with the CONTRACT DOCUMENTS.
- 18.4 After ten (10) days from delivery of a WRITTEN NOTICE to the CONTRACTOR and the ENGINEER, the OWNER may, without cause and without prejudice to any other right or remedy, elect to abandon the PROJECT and terminate the CONTRACT. In such case, the CONTRACTOR shall be paid for all WORK executed and any expense sustained plus reasonable profit.
- 18.5 If, through no act or fault of the CONTRACTOR, the WORK is suspended for a period of more than ninety (90) days by the OWNER or under an order of court or other public authority, or the ENGINEER fails to act on any request for payment within thirty (30) days after it is submitted, or the OWNER fails to pay the CONTRACTOR substantially the sum approved by the ENGINEER or awarded by arbitrators within thirty (30) days or its approval and presentation, the CONTRACTOR may, after ten (10) days from delivery of a WRITTEN NOTICE to the OWNER and the ENGINEER, terminate the CONTRACT and recover from the OWNER payment for all WORK executed and all expenses sustained. In addition and in lieu of terminating the CONTRACT, if the ENGINEER has failed to act on a request for payment or if the OWNER has failed to make any payment as aforesaid, the CONTRACTOR may upon ten (10) days written notice to the OWNER and the ENGINEER stop the WORK until he has been paid all amount then due, in which event and upon resumption of the WORK, CHANGE ORDERS shall be issued for adjusting the CONTRACT PRICE or extending the CONTRACT TIME or both to compensate for the costs and delays attributable to the stoppage of the work.
- 18.6 If the performance of all or any portion of the WORK is suspended, delayed or interrupted as a result of a failure of the OWNER or ENGINEER to act within the time specified in the CONTRACT DOCUMENTS or if no time is specified, within a reasonable time, an adjustment in the CONTRACT PRICE or an extension of the CONTRACT TIME or both shall be made by CHANGE ORDER to compensate the CONTRACTOR for the costs and delays necessarily caused by the failure of the OWNER or ENGINEER.

19. PAYMENTS TO CONTRACTOR

- 19.1 At least ten (10) days before each progress payment falls due (but not more often than once a month), the CONTRACTOR will submit to the ENGINEER a partial payment estimate filled out and signed by the CONTRACTOR covering the WORK performed during the period covered by the partial payment estimate and supported by such data as the ENGINEER may reasonably require. If payment is requested on the basis of materials and equipment not incorporated in the WORK but delivered and suitably stored at or near the site, the partial payment estimate shall also be accompanied by such supporting data, satisfactory to the OWNER, as will establish the OWNER'S title to the material and equipment and protect his interest therein, including applicable insurance.
- 19.2 The request for payment may also include an allowance for the cost of such major materials and equipment which are suitable stored either at or near the site.
- 19.3 Prior to SUBSTANTIAL COMPLETION, the OWNER with the approval of the ENGINEER and with the occurrence of the CONTRACTOR may use any completed or substantially completed portions of the WORK. Such use shall not constitute an acceptance of such portions of the WORK.
- 19.4 The OWNER shall have the right to enter the premises for the purpose of doing work not covered by the CONTRACT DOCUMENTS. This provision shall not be construed as relieving the CONTRACTOR of the sole responsibility for the care and protection of the WORK, or the restoration of any damaged WORK except such as may be caused by agents or employees of the OWNER.
- 19.5 Deleted
- 19.6 The CONTRACTOR will indemnify and save the OWNER or the OWNER'S agents harmless from all claims growing out of the lawful demands of SUBCONTRACTORS, laborers, workmen, mechanics, materialmen, and furnishers of machinery and parts thereof, equipment, tools, and all supplies, incurred in the furtherance of the WORK. The CONTRACTOR shall, at the OWNER'S request, furnish satisfactory evidence that all obligations of the nature designated above have been paid, discharged, or waived.
- 19.7 Deleted

20. ACCEPTANCE OF FINAL PAYMENT AS RELEASE

- 20.1 The acceptance by the CONTRACTOR of final payment shall be and shall operate as a release to the OWNER of all claims and all liability to the CONTRACTOR other than claims in stated amounts as may be specifically excepted by the CONTRACTOR for all things done or furnished in connection with this WORK and every act and neglect of the OWNER and others relating to or arising out of this WORK. Any payment, however, final or otherwise, shall not release the CONTRACTOR or his sureties from any obligations under the CONTRACT DOCUMENTS or the PERFORMANCE BOND and PAYMENT BONDS.

21. INSURANCE

- 21.1 The CONTRACTOR shall purchase and maintain such insurance as will protect him from claims set forth below which may arise out of or result from the CONTRACTOR'S execution of the WORK, whether such execution be by himself or by any SUBCONTRACTOR or by anyone directly or indirectly employed by any of them, or by anyone for whose acts any of them may be liable:
- 21.1.1 Claims under workmen's compensation, disability benefit and other similar employee benefit acts;
- 21.1.2 Claims for damages because of bodily injury, occupational sickness or disease, or death of his employees;
- 21.1.3 Claims for damages because of bodily injury, sickness or disease, or death of any person other than his employees;
- 21.1.4 Claims for damages insured by usual personal injury coverage which are sustained (1) by any person as a result of an offense directly or indirectly related to the employment of such person by the CONTRACTOR, or (2) by any other person; and
- 21.1.5 Claims for damages because of injury to or destruction of tangible property, including loss of use resulting therefrom.

- 21.2 Certificates of Insurance acceptable to the OWNER shall be filed with the OWNER prior to commencement of the WORK. These Certificates shall, contain a provision that coverage's afforded under the policies will not be canceled unless at least fifteen (15) days prior WRITTEN NOTICE has been give to the OWNER.
- 21.3 The CONTRACTOR shall procure and maintain, at his own expense, during the CONTRACT TIME, liability insurance as hereinafter specified;
- 21.3.1 CONTRACTOR'S General Public Liability and Property Damage Insurance including vehicle coverage issued to the CONTRACTOR and protecting him from all claims for personal injury, including death, and all claims for destruction of or damage to property, arising out of or in connection with any operations under the CONTRACT DOCUMENTS, whether such operations be by himself or by any SUBCONTRACTOR under him, or anyone directly or indirectly employed by the CONTRACTOR or by a SUBCONTRACTOR under him. Insurance shall be written with a limit liability of not less than \$500,000 for all damages arising out of bodily injury, including death, at any time resulting therefrom, sustained by any one person in any one accidental; and a limit of liability of not less than \$500,000 aggregate for any such damages sustained by two or more persons in any one accident. Insurance shall be written with a limit of not less than \$500,000 for all property damage sustained by any one person in any one accident; and a limit of liability of not less than \$1,000,000 aggregate for any such damage sustained by two or more persons in any one accident. The CONTRACTOR'S Public Liability Insurance separate policies of the same limits, coverage for all hazards inherent in the WORK of the CONTRACT. Without limiting the foregoing statement, the insurance shall cover any of the following hazards which may be present in the CONTRACT:
- Explosion, collapse and underground damage; damage to property in the CONTRACTOR'S care, custody or control; rigging and hoisting. The insurance required by Paragraph 21.3.2 is not required.
- 21.3.2 The CONTRACTOR shall acquire and maintain, if applicable, Fire and Extended Coverage Insurance upon the PROJECT to the full insurable value thereof for the benefit of the OWNER, the CONTRACTOR, and SUBCONTRACTORS as their interest may appear. This provision shall in no way release the CONTRACTOR OR CONTRACTOR'S surety from obligations under the CONTRACT DOCUMENTS to fully complete the PROJECT.
- 21.4 The CONTRACTOR shall procure and maintain, at his own expense, during the CONTRACT TIME, in accordance with the provisions of the laws of the state in which the WORK is performed. Workmen's Compensation Insurance and Employer's Liability Insurance, including occupational disease provisions, for all of his employees at the site of the PROJECT and in case any work is sublet, the CONTRACTOR shall require such SUBCONTRACTOR similarly to provide Workmen's Compensation Insurance and Employer's Liability Insurance, including occupational disease provisions for all of the latter's employees unless such employees are covered by the protection afforded by the CONTRACTOR. In case any class of employees engaged in hazardous work under this CONTRACT at the site of the PROJECT is not protected under Workmen's Compensation statute, the CONTRACTOR shall provide, and shall cause each SUBCONTRACTOR to provide adequate and suitable insurance for the protection of his employees not otherwise protected.
- 21.5 The CONTRACTOR shall secure, if applicable, "All Risk" type builder's Risk Insurance for WORK to be performed. Unless specifically authorized by the OWNER, the amount of such insurance shall not be less than the CONTRACT PRICE totaled in the BID. The policy shall cover not less than the losses due to fire, explosion, hail, lightning, vandalism, malicious mischief, wind, collapse, riot, aircraft, and smoke during the CONTRACT TIME, and until the WORK is accepted by the OWNER. The policy shall name as the insured the CONTRACTOR, the ENGINEER and the OWNER.
- 21.6 The CONTRACTOR shall secure and maintain insurance to cover the INDEMNIFICATION required by Paragraph 24 of the General Conditions. The provisions of Paragraph 24.1 shall be recited in full on the reverse side of the certificate evidencing such insurance.
- 21.7 The CONTRACTOR shall secure and maintain OWNER'S Protective Liability Insurance coverage naming the OWNER as insured with the same limits and coverages as the CONTRACTOR'S General Public Liability and Property Damage Insurance. This insurance shall be in addition to the coverages provided by Paragraphs 21.3.1 and 21.6, but shall not duplicate any coverage therein provided.

22. CONTRACT SECURITY

22.1 The CONTRACTOR shall within ten (10) days after the receipt of the NOTICE OF AWARD furnish the OWNER with a Performance Bond and a Payment Bond in penal sums equal to the amount of the CONTRACT PRICE, conditioned upon the performance by the CONTRACTOR of all undertakings, covenants, terms, conditions and agreements of the CONTRACT DOCUMENTS, and upon the prompt payment by the CONTRACTOR to all persons supplying labor and materials in the prosecution of the WORK provide by the CONTRACT DOCUMENTS. Such BONDS shall be executed by the CONTRACTOR and a corporate bonding company licensed to transact such business in the state in which the WORK is to be performed and named on the current which the WORK is to be performed and named on the current list of "Surety Companies Acceptable on Federal Bonds" as published in the Treasury Department Circular Number 570. The expense of these BONDS shall be borne by the CONTRACTOR. If at any time a surety on any such BOND is declared bankrupt or loses its right to do business in the state in which the WORK is to be performed or is removed from the list of surety Companies accepted on Federal BONDS. CONTRACTOR shall within ten (10) days after notice from the OWNER to do so, substitute an acceptable BOND (or BONDS) in such form and sum and signed by such other surety or sureties as may be satisfactory to the OWNER. The premiums on such BOND shall be paid by the CONTRACTOR. No further payments shall be deemed due nor shall be made until the new surety or sureties shall have furnished an acceptable BOND to the OWNER.

23. ASSIGNMENTS

23.1 Neither the CONTRACTOR nor the OWNER shall sell, transfer, assign or otherwise dispose of the CONTRACT or any portion thereof, or of his right, title or interest therein, or his obligations thereunder, without written consent of the other party.

24. INDEMNIFICATION

24.1 The CONTRACTOR will indemnify and hold harmless the OWNER and the ENGINEER and their agents and employees from and against all claims, damages, losses and expenses including attorney's fees arising out of or resulting from the performance of the WORK, provided that any such claims, damage, loss or expense is attributable to bodily injury, sickness, disease or death, or to injury to or destruction of tangible property, including the loss of use resulting therefrom; and is caused in whole or in part by any negligent or willful act or omission of the CONTRACTOR, and SUBCONTRACTOR, anyone directly or indirectly employed by any of them or anyone for whose acts any of them may be liable.

24.2 In any and all claims against the OWNER or the ENGINEER, or any of their agents or employees, by any employee of the CONTRACTOR, any SUBCONTRACTOR, anyone directly or indirectly employed by any of them, or anyone for whose acts any of them may be liable, the indemnification obligation shall not be limited in any way by any limitation on the amount or type of damages, compensation or benefits payable by or for the CONTRACTOR or any SUBCONTRACTOR under Workmen's Compensation acts, disability benefit acts or other employee benefits acts.

24.3 The obligation of the CONTRACTOR under this paragraph shall not extend to the liability of the ENGINEER, his agents or employees arising out of the preparation or approval of maps, DRAWINGS, opinions, reports, surveys, CHANGE ORDERS, designs or SPECIFICATIONS.

25. SEPARATE CONTRACTS

25.1 The OWNER reserves the right to let other contracts in connection with this PROJECT. The CONTRACTOR shall afford other CONTRACTORS reasonable opportunity for the introduction and storage of their materials and the execution of their WORK, and shall properly connect and coordinate his WORK, and shall properly connect and coordinate his WORK with theirs. If the proper execution or results of any part of the CONTRACTOR'S WORK depends upon the WORK of any other CONTRACTOR, the CONTRACTOR shall inspect and promptly report to the ENGINEER any defects in such WORK that render it unsuitable for such proper execution and results.

25.2 The OWNER may perform additional WORK related to the PROJECT by himself, or he may let other contracts containing provisions similar to these. The CONTRACTOR will afford the other CONTRACTORS who are parties to such CONTRACTS (or the OWNER, if he is performing the additional WORK himself), reasonable opportunity for the introduction and storage of materials and

equipment and the execution of WORK, and shall properly connect and coordinate his WORK with theirs.

- 25.3 If the performance of additional WORK by other CONTRACTORS or the OWNER is not noted in the CONTRACT DOCUMENTS prior to the execution of the CONTRACT, written notice thereof shall be given to the CONTRACTOR prior to starting any such additional WORK. If the CONTRACTOR believes that the performance of such additional WORK by the OWNER or others involves him in additional expense or entitles him to an extension of the CONTRACT TIME, he may make a claim therefor as provided in Sections 14 and 15.

26. SUBCONTRACTING

- 26.1 The CONTRACTOR may utilize the services of specialty SUBCONTRACTORS on those parts of the WORK which, under normal contracting practices, are performed by specialty SUBCONTRACTORS.
- 26.2 The CONTRACTOR shall not award WORK to SUBCONTRACTOR(S), in excess of fifty (50%) percent of the CONTRACT PRICE, without prior written approval of the OWNER.
- 26.3 The CONTRACTOR shall be fully responsible to the OWNER for the acts and omissions of his SUBCONTRACTORS, and of persons either directly or indirectly employed by them, as he is for the acts and omissions of persons directly employed by him.
- 26.4 The CONTRACTOR shall cause appropriate provisions to be inserted in all subcontracts relative to the WORK to bind SUBCONTRACTORS to the CONTRACTOR by the terms of the CONTRACT DOCUMENTS in so far as applicable to the WORK OF SUBCONTRACTORS and to give the CONTRACTOR the same power as regards terminating any subcontract that the OWNER may exercise over the CONTRACTOR under any provision of the CONTRACT DOCUMENTS.
- 26.5 Nothing contained in this CONTRACT shall create any contractual relation between any SUBCONTRACTOR and the OWNER.

27. ENGINEER'S AUTHORITY

- 27.1 The ENGINEER shall act as the OWNER'S representative during the construction period. He shall decide questions which may arise as to quality and acceptability of materials furnished and WORK performed. He shall interpret the intent of the CONTRACT DOCUMENTS in a fair and unbiased manner. The ENGINEER will make visits to the site and determine if the WORK is proceeding in accordance with the CONTRACT DOCUMENTS.
- 27.2 The CONTRACTOR will be held strictly to the intent of the CONTRACT DOCUMENTS in regard to the quality of materials, workmanship and execution of the WORK. Inspections may be made at the factory or fabrication plant of the source of material supply.
- 27.3 The ENGINEER will not be responsible for the construction means, controls, techniques, sequences, procedures, or construction safety.
- 27.4 The ENGINEER shall promptly make decisions relative to interpretation of the CONTRACT DOCUMENTS.

28. LAND AND RIGHTS-OF-WAY

- 28.1 Prior to issuance of NOTICE TO PROCEED, the OWNER shall obtain all land and rights-of-way necessary for carrying out and for the completion of the work to be performed pursuant to the CONTRACT DOCUMENTS, unless otherwise mutually agreed.
- 28.2 The OWNER shall provide to the CONTRACTOR information which delineates and describes the lands owned and rights-of-way acquired.
- 28.3 The CONTRACTOR shall provide at his own expense and without liability to the OWNER any additional land and access thereto that the CONTRACTOR may desire for temporary construction facilities, or for storage of materials.

29. GUARANTY

- 29.1 The CONTRACTOR shall guarantee all materials and equipment furnished and WORK performed for a period of one (1) year from the date of SUBSTANTIAL COMPLETION. The CONTRACTOR warrants and guarantees for a period of one (1) year from the date of SUBSTANTIAL COMPLETION of the system that the completed system is free from all defects due to faulty materials or workmanship and the CONTRACTOR shall promptly make such corrections as may be necessary by reason of such defects including the repairs of any damage to other parts of the system resulting from such defects. The OWNER will give notice of observed defects with reasonable promptness. In the event that the CONTRACTOR the cost thereby incurred. The PERFORMANCE BOND shall remain in full force and effect throughout the guarantee period.

30. ARBITRATION

- 30.1 All claims, disputes and other matters in question arising out of, or relating to, the CONTRACT DOCUMENTS or the breach thereof, except for claims which have been waived by the making and acceptance of final payment as provided by Section 20, shall be decided by arbitration in accordance with the Construction Industry Arbitration Rules of the American Arbitration Association. This agreement to arbitrate shall be specifically enforceable under the prevailing arbitration law. The award rendered by the arbitrators shall be final, and judgment may be entered upon it in any court having jurisdiction thereof.
- 30.2 Notice of the demand for arbitration shall be filed in writing with the other party to the CONTRACT DOCUMENTS AND WITH THE American Arbitration Association, and a copy shall be filed with the ENGINEER. Demand for arbitration shall in no event be made on any claim, dispute or other matter in question which would be barred by the applicable statute of limitations.
- 30.3 The CONTRACTOR will carry on the WORK and maintain the progress schedule during any arbitration proceedings, unless otherwise mutually agreed in writing.
- 30.4 The provisions for Arbitration will apply if both parties mutually agree. If no agreement can be reached, disputes will be entered into a court of competent jurisdiction within the state.

31. TAXES

- 31.1 The OWNER is an exempt purchaser under the Sales Act, Chapter 14 of the Acts of 1966 to the extent that materials and supplies are used or incorporated in the performance of the CONTRACT. The CONTRACTOR shall obtain from the OWNER an exemption certificate number to be used in lieu of paying the tax on exempted items.

32. ADDITIONAL PROVISIONS

- 32.1 The SPECIFICATIONS and the DRAWINGS are intended to describe and provide for a completed PROJECT. They are intended to be complementary, and what is called for by either shall be complete in every detail, notwithstanding that every item necessarily involved is not particularly mentioned, and the CONTRACTOR shall provide all labor and materials necessary for the entire completion of the WORK intended to be described.
- 32.2 Site Regulations
- a. Removal of Rubbish and Temporary Facilities
On or before the completion of the work, the CONTRACTOR shall without charge therefor tear down and remove all buildings and other temporary structures built by him, and shall remove surplus material and rubbish of all kinds from any ground which he has occupied and shall leave the work, grounds and surroundings in clean and neat condition.
 - b. Tobacco and Liquor Prohibited.
The CONTRACTOR shall neither permit nor suffer smoking where it creates a hazard nor the introduction or use of spirituous or intoxicating liquors upon or about the works embraced in this CONTRACT or upon any of the ground occupied by him.
 - c. Posters
The CONTRACTOR shall not permit or suffer any placards, posters or advertisements to be displayed on or about the premises unless approved by the OWNER.

33. LIMITATIONS OF DATA PRESENTED.

- 33.1 Drawings, surveys, measurements, dimensions, calculations, estimates, borings and statements as to the condition under which the WORK is to be performed are believed to be correct.
- 33.2 The BIDDER shall carefully examine the CONTRACT DOCUMENTS, including all DRAWINGS, SPECIFICATIONS and ADDENDA, shall visit the site, and shall satisfy himself as to the type and quantity of the WORK to be done. For the purposes of comparing several proposal's bids shall be based on the data presented and the BIDDER'S examination of the site.
- 33.3 The locations of all utilities are obtained from the best available sources, and are to be considered as approximate in so far as size, location and elevation are concerned. Furthermore, it is expressly understood that there may be utilities in existence other than those shown on the DRAWINGS.

34. ADDENDA AND INTERPRETATIONS

All questions by prospective bidders as to the interpretation of Information for Bidders, Form of Proposals, Form of Contract, Drawings, Specifications of form of Performance Bond and Labor and Materials or Payment bond must be submitted in writing to the Engineer and must be in their possession at least ten days before the date herein set for the receipt of bids. The Engineer will then mail by certified mail with return receipt requested, to bidders who have taken out the contract documents, at the addresses given by them, not less than five calendar days before said date, interpretations of all questions so raised which, in their opinion, require interpretation.

NOTICE OF AWARD

TO:

PROJECT DESCRIPTION: MILLING & OVERLAY OF VARIOUS ROADS PROJECT (A)

The OWNER has considered the BID submitted by you for the above-described WORK in response to its Advertisement for Bids and Information for Bidders posted on MARCH 6, 2024.

You are hereby notified that your BID has been accepted for items in the amount of \$_____.

You are required by the Information for Bidders to execute the Agreement and furnish the required CONTRACTOR'S Performance Bond, Payment Bond, and Certificates of Insurance within ten (10) calendar days from the date of this Notice to you.

If you fail to execute said Agreement and to furnish said BONDS within ten (10) days from the date of this Notice, said OWNER will be entitled to consider all your rights arising out of the OWNER'S acceptance of your BID as abandoned and as a forfeiture of your BID BOND. The OWNER will be entitled to such other rights as may be granted by law.

You are required to return an acknowledged copy of this NOTICE OF AWARD to the OWNER.

DATED THIS:

OWNER: **TOWN OF HUDSON**

ERIC M RYDER
DIRECTOR OF PUBLIC WORKS

ACCEPTANCE OF NOTICE

Receipt of the above NOTICE OF AWARD is hereby acknowledged by:

_____ This the _____ day
of _____, 2024.

BY: _____ TITLE: _____

CHANGE ORDER

ORDER NO: _____

DATE: _____

AGREEMENT DATE: _____

NAME OF PROJECT: _____

OWNER: _____

CONTRACTOR: _____

The following changes are hereby made to the CONTRACT DOCUMENTS:

JUSTIFICATION: _____

Change to CONTRACT PRICE: \$ _____

Original CONTRACT PRICE: \$ _____

Current CONTRACT PRICE adjusted by previous CHANGE ORDER: \$ _____

The CONTRACT PRICE due this CHANGE ORDER will be (increased) (decreased) by: \$ _____

The new CONTRACT PRICE including this CHANGE ORDER will be: \$ _____

Change to CONTRACT TIME: _____

The CONTRACT TIME will be (increased) (decreased) by _____ calendar days.

The DATE for completion of all work will be _____

REQUESTED BY: _____

RECOMMENDED BY: _____

ORDERED BY: _____

ACCEPTED BY: _____

DIVISION I: GENERAL REQUIREMENTS

SECTION 1A - MEASUREMENT AND PAYMENT

1. MEASUREMENT AND PAYMENT FOR DIVISION II

- 1-1 Section 9.00 of the Commonwealth of Massachusetts Mass Highway Department Standard Specification for Highways and Bridges is hereby included in its entirety.
- 1-2 All work items for Division II of this project are referenced with Item Numbers and Item Descriptions similar to those currently in use by the Massachusetts Highway Department.
- 1-3 Method of Measurement and Basis of Payment for each work item shall be as called for under the appropriate section of the Mass Highway Standard Specifications, unless modified herein.

DIVISION I: GENERAL REQUIREMENTS

SECTION 1B - SPECIAL REQUIREMENTS

- 1. UTILITIES** - Utility work may be undertaken by the respective Owners as a part of this project. Coordination and cooperation with these utilities is essential for the swift and satisfactory completion of this project. The contractor shall contact each of the utilities which may in any way be affected and shall allow in his schedule sufficient time for the utilities to complete their work.
- 2. EXCAVATION** - Open excavations adjacent to the roadway shall not remain open through the hours of darkness, holidays or periods of shut-down, unless adequately protected and specifically authorized.
- 3. ROCK EXCAVATION** - No blasting will be permitted on Saturdays, Sundays, or holidays unless specifically authorized. Prior to blasting, the Contractor shall notify all owners or residents within ¼ mile radius at least 24 hours in advance of said blasting operations.
- 4. TESTING OF MATERIALS** - The testing of materials constructed under this contract may be ordered at any time. If the results of the test indicate conformance with the specifications, the Town will assume the cost of the testing. If not in conformance, the Contractor will be liable for the cost of the test.
- 5. PLANS AT SITE** - The Contractor is to keep a copy of this contract and accompanying plans at the site of the work at all times while work is being performed and said copy is to be available to those in charge of the work. A copy of the latest edition of the Mass Highway Standard Specifications shall also be kept on site.
- 6. PROGRESS OF THE WORK** - The Contractor shall start and continue actual construction work under this contract with the necessary equipment to properly execute and complete this contract in the specified time. No cessation of Contractor's operations will be allowed without the approval of the Engineer. The rate of progress shall be satisfactory to the Owner and the Engineer. The Contractor shall furnish to the Engineer a progress schedule for the work.

DIVISION I: GENERAL REQUIREMENTS

SECTION 1C: SPECIAL PROVISIONS

1. LOCATION AND WORK

The work under this contract consists of the provision of all-necessary labor, materials and equipment for the COMPLETE STREETS FUNDING PROGRAM / MILLING & OVERLAY OF VARIOUS ROADS PROJECT (A) IN HUDSON.

Please refer to locus plan and site plan. The precise, location for the MILLING & OVERLAY OF VARIOUS ROADS PROJECT (A) IN HUDSON.

The Contractor shall conduct his own investigation and research on the sites and detail enclosed regarding all conditions affecting the work, the amount of labor, materials and equipment needed, and to make an appropriate bid.

All materials and equipment of the Contractor that is left on site shall be at Contractor's own risk. The Hudson Department of Public Works shall not be responsible for any damage or theft incurred.

2. ENGINEER

The Director of Public Works or his designee will perform the duties of the Engineer for this contract.

3. SAFETY MEASURES

The Contractor shall furnish, install, maintain and move at his own expense, all warning devices, barricades, signs, detours and other safety measures deemed necessary by the Engineer for the protection of motorists, pedestrians and the Contractor's own personnel. Attention is drawn, in particular, to the safe working requirements for confined spaces.

4. PUBLIC ACCESS

Vehicle and Pedestrian travel on the public way shall be maintained during construction and access to abutting land shall be provided at all times.

DIVISION II: ITEMS

QUALITY OF WORK SPECIFICATIONS

The work under this Contract consists of furnishing all necessary labor, materials and equipment required to install hot mix asphalt leveling and top courses on several streets located in the Town of Hudson, MA.

The work also requires site preparation, repair and adjustment of drainage structures and gate boxes, street sweeping, application of asphalt tack coat. Tack Coat shall consist of RC-70 cutback asphalt or rapid setting RS-1 emulsified asphalt applied at the rate between 0.05 and 0.15 gallons per square yard, construction-related safety signage, minor restoration work, and all other related activities whatsoever required to complete the asphalt overlays as specified herein and as directed by the Engineer. The streets to be milled and overlaid are identified on R PROJECT A SCOPE of this bid package, however, the Town reserves the right to delete streets and/or quantities from the project if unforeseen circumstances arise or add streets and/or quantities to the project if schedule and budget allow.

Unit bid prices submitted shall apply to quantities either added or deleted during the work. The Town requires that all hot mix asphalt installed under this project be batched and delivered from a batching plant within a 20 mile radius of the street being paved.

All work done under this contract shall be in conformance with the Massachusetts Highway Department Standard Specifications for Highways and Bridges, dated 2024, and any revisions thereto, the English Edition of the Supplemental Specifications to the Standard Specifications for Highways and Bridges, the MassDOT 2017 Construction Standard Details, the 2009 Manual on Uniform Traffic Control Devices with all revisions up to and inclusive of 2024, the 2010 ADA Standards for Accessible Design, the Massachusetts Architectural Access Board Rules and Regulations (521 C.M.R.) and the following special provisions.

GUARANTEE AFTER FINAL ACCEPTANCE:

The Contractor shall, at his own expense, replace any work performed under this Contract found to be defective in workmanship, material, or manner of functioning within twelve (12) months from date of final acceptance of all the installations under this Contract.

CONSTRUCTION SAFETY (Supplementing Subsection 7.00 of MassDOT Specifications)

Due to hazardous conditions encountered by working in public streets, all contractor personnel are required to wear reflectorized safety vests while working in or near the roadway. The Contractor shall furnish such vests and shall maintain a sufficient supply of such vests at the work site for the Contractor's personnel and any other personnel assigned to or visiting the work site. The cost of furnishing such vests shall be part of the prices bid for the various items of the Contract, and such vests shall remain the property of the Contractor.

PUBLIC SAFETY AND CONVENIENCE (Supplementing Subsection 7.09 of MassDOT Specifications)

The Contractor shall provide necessary access for fire apparatus and other emergency vehicles through the work zones to abutting properties at all times. Sweeping and cleaning of surfaces beyond the limits of the project to clean up material caused by spillage or vehicular tracking during the various phases of the work shall be considered as incidental to the work being performed under the Contract and there will be no additional compensation. Project Contact: Town of Hudson Operations Manager Department of Public Works 1 Municipal Drive, MA 01749

PROTECTION AND RESTORATION OF PROPERTY (Supplementing Subsection 7.13)

In case of damage to utilities, the Contractor shall promptly notify the Utility Owner, Town, and the Engineer, and shall, if requested by the Town, furnish labor support to work temporarily under the Utility Owner's direction in providing access to the utility. The cost of such work shall be borne by the Contractor, without compensation therefore. "DIG SAFE", Call Center 811 or 1-888-344-7233 The Contractor shall make his own investigation to assure that no damage occurs to existing structures, drainage lines, traffic signal conduits, and other utilities as a result of his operations. The Contractor shall notify Mass. DIG-SAFE and obtain permit number prior to disturbing the ground in any way. Full compensation for furnishing all labor, materials, tools, equipment, and incidentals and for doing all the work involved in protecting or repairing property as specified in this section shall be included in the Contract prices bid, and no additional compensation will be allowed therefore.

CONSTRUCTION STAKING AND LAYOUT (Supplementing Subsection 5.07 of the MassDOT Standard Specifications)

The Contractor shall be responsible to establish the baselines or centerlines and edgelines of construction for the project. The Contractor shall furnish and set, at his own expense, all stakes (such as batter boards, slope stakes, pins, offset stakes, etc.) required for the construction operations and he shall be solely responsible for the accuracy of the line and grade of all features of his work. The Contractor shall be responsible for maintaining all benchmarks, control stations, and other survey control points. The Contractor shall be held responsible for the preservation of all stakes and marks. If any such stakes or marks are disturbed or destroyed by the Contractor, he shall replace said stakes at his own expense. The cost of construction layout shall be incidental with the various other items under the contract.

WORK SCHEDULE

Work on this project is restricted to a normal eight-hour day, five-day week, starting at 7:00 A.M. and ending at 3:00 P.M., with the Contractor and all Subcontractors working on the same shift. No work shall be performed on this Contract on Saturday, Sunday, a Federal, State or Town of Hudson Holiday, on the days before or after a long weekend that involves a holiday or outside of the 7:00 A.M. to 3:00 P.M. normal workday without prior approval of the Town.

COMMUNICATIONS

The Contractor shall provide continuous radio communications between the asphalt plant and the project to assure immediate response due to breakdowns, emergencies such as accidents, and to assure the best quality results possible. Communication shall be provided by the Contractor at no additional compensation.

WORK ON PRIVATE PROPERTY

For Driveway transitions, if necessary, performance of designated re-grading and related construction work outside the limits of the roadway layout is dependent upon the obtainment of rights of entry or construction easements from private owners by the Town. No work shall be done in these areas until clearance is given by the Town.

EXAMINATION OF CONTRACT DOCUMENTS

Each bidder is responsible for inspecting the sites and for reading and being thoroughly familiar with the contract documents. The failure or omission of any bidder to do any of the foregoing shall in no way relieve any bidder from any obligation in respect to his bid. Bidders must satisfy themselves of the accuracy of the estimated quantities in the bid schedule by examination of the sites and a review of any drawings, specifications and addenda provided. After bids have been submitted, the Bidder shall not assert that there was a misunderstanding concerning the quantities of work or of the nature of the work to be done.

BOUNDS

Bounds or property line markers disturbed by the Contractor shall be replaced and/or realigned by the Contractor. No payment shall be made for replacement or resetting required for the convenience of the Contractor. The Contractor shall submit sketches of the location of each reset bound to the Design Engineer and the Town of Hudson, showing at least three tie points. The sketch shall be stamped by a Professional Land Surveyor registered in Massachusetts.

DISPOSAL OF SURPLUS MATERIALS

After approval from the Engineer, all existing and other materials not required or needed for use on the project, and not required to be removed and stacked, shall become the property of the Contractor and shall be removed from the site during the construction period and legally disposed of. No separate payment will be made for this work, but all costs in connection therewith shall be included in the prices bid for various Contract items.

SAW-CUTS

Saw-cuts shall be made in existing pavement at the limits of work, in areas of new or reset curb, driveways and sidewalks, limits of full depth pavement construction / reclamation as shown on the plans or as directed by the Town. Payment for this work shall be considered incidental to the Contract unit prices bid.

OVERLOADED TRUCKS

The Town will not allow any materials delivered to any project in motor vehicles or semi-trailer units that exceed the legal maximum gross weight allowed for the particular class as specified in Section 19A of Chapter 90 of the General Laws of Massachusetts. The provisions of Subsection 7.03 of the Standard Specifications shall still apply.

DRAINAGE STRUCTURES AND PIPES

It shall be the Contractor's responsibility to maintain properly functioning drainage in the areas under construction prior to the time when final acceptance is made. All pipes and structures (existing and proposed) within the limits of this Contract shall be left in clean and operable condition at the completion of the work. The Contractor will be required to clean existing structures and pipes if clogged during execution of the work. It is a requirement of this Contract, pending installation of castings, that all structures in travel ways shall be protected with suitable covers (steel plates or equal) capable of withstanding a 36.5 ton truckload with impact. Payment for the covers shall be considered incidental to the Contract unit prices bid.

MILLING / COLD PLANING

The milling shall be started at the centerline of the pavement and proceed on a longitudinal line parallel to the centerline. Succeeding passes shall progress toward the outer edge of the pavement unless a different sequence of operation is permitted by the Town. The Contractor shall make every effort to complete the milling operations on the full width of each street so that it is open to traffic at the end of each day, unless otherwise approved by the Town. The milled depth shall be gradually tapered to the original pavement surface prior to opening to traffic. Before overlaying, the gradual taper to the original pavement surface shall be milled out transversely to produce a vertical cut.

The completed milled surface shall be free from transverse and longitudinal irregularities exceeding 1/4 inch when measured with a 10-foot straightedge.

There are traffic light intersections within the scope of this project.

In areas that have existing detector loops or microprobes, the Town will work with the contractor to disconnect the loops prior to milling operations and will install new loops prior to overlay operations or reconfigure the traffic pattern as needed. The Contractor shall haul and dispose of all milled material. All equipment necessary for hauling and disposal of milled material will be furnished by the Contractor.

Machine exhaust shall not damage or scorch any parts of trees.

The Contractor shall mill around appurtenances such as manhole and valve box castings without removing those appurtenances. If any asphalt remains on the face of the exposed curb and gutter section or radii around appurtenances, it must be removed to a depth of the milled surface. Appurtenances in the driving lanes shall be wedged with asphalt millings which shall be removed prior to the overlay. Appurtenances not wedged shall be marked with a Type II barricade.

The Contractor shall clean the milled surface by brooming and remove all equipment and materials prior to opening to traffic.

PAVEMENT OPERATIONS

No less than a week in advance before the scheduled start of construction operations, a meeting will be held in which representatives from the Contractor and the Town will come to an agreement on the details for the milling and paving operation including but not limited to Hot Mix Asphalt delivery and placement, amount of days that pavement operations are expected to last, the need for detours (traffic plan), amount of trucks that will be needed, paver speed, etc. Paving equipment shall have been capable of using automatic screed control (Automatic Grade Control). A tack coat shall be spread per MassDOT specifications. Surface shall be dry and cleaned of all foreign and loose material by means of a machine sweeper before applying Tack Coat. Tack distributor shall be working properly and should be setup correctly. Tack distributor shall be capable of maintaining proper temperature and pressure and also capable of adjusting the spray bar height throughout the day to ensure proper coverage and even application of the tack coat. The material and labor costs for the application of tack coat are incidental to Item 460.0. The Town requires that all hot mix asphalt installed under this project be batched and delivered from a batching plant within a 20 mile radius of the street being paved.

CLEARING AND GRUBBING

The clearing and grubbing required for this contract will be minimal given the nature of the work under this contract. As such, any required clearing and grubbing shall be considered incidental to the payment items on this contract.

TRAFFIC MANAGEMENT

Traffic Management during construction operations shall be in accordance with these Special Provisions, the Manual on Uniform Traffic Control Devices, Latest Edition and Supplements, and the Town of Hudson.

UNIFORMED TRAFFIC OFFICERS

The attention of the Bidder is directed to the requirements of Subsection 7.11 (including amendments) of the 1988 Standard Specifications for Highways and Bridges. Uniformed Traffic Police officers will be required during the construction period. It will be the Town of Hudson's responsibility to bear the cost for the police details but it will be the contractor's responsibility to bear the costs of any canceled details that are charged and to call the police department and schedule the police details on time and with enough notice to allow the police department to be able fill the police detail request. Prior to scheduling the police detail, the contractor shall meet with the engineer with enough time in advance to determine and come to an agreement on how many police officers the detail(s) will require for the upcoming working day(s). On days where the contractor and the engineer have agreed that a police detail is needed, the contractor will not be allowed to start working until the police detail is in place on site. The contractor shall maintain and provide the engineer with a daily record of the names of the officers, the hours worked and the location of assignment for every police detail throughout the course of this contract. Cancellation of any scheduled police detail due to inclement weather or any other reason shall be the responsibility of the Contractor and shall be made with enough notice to the Police Department. The intent is to insure public safety by police direction of traffic. Police are not to serve as watchmen over the Contractor's equipment and materials, or to warn pedestrians of such hazards as open trenches. Nothing contained herein shall be construed as relieving the Contractor of any of their responsibilities for protection of persons and property under the terms of the Contract.

EMERGENCY VEHICLE ACCESS AND SAFETY SIGNAGE

Fire apparatus and other emergency vehicles shall have necessary access at all times. The Contractor shall coordinate with the Police and Fire departments on a daily basis regarding access. Traffic control signage for construction and maintenance operations (ITEM 851) shall be mounted on portable supports and covered or removed when not in use. No signs shall be visible to traffic that may conflict with actual conditions. It shall be the responsibility of the Contractor to maintain a reasonably safe uninterrupted traffic flow within the project roadways throughout the duration of the project. Detours onto surrounding streets will not be allowed unless approved by the Town of Hudson. Detours shall have appropriate signs directing traffic along the entire detour route. Work to be done under these items shall conform to the relevant provisions of Section 850 and the following: All signs, barricades, and drums shall have Reflective Sheeting in accordance with Material

Drums shall meet the requirements of Section M9.30.9 Plastic drums with mounted lighting devices must pass the criteria set forth in NCHRP 350 "Recommended Procedures for the Safety Performance Evaluation of Highway Features". Plastic drums with mounted lighting devices that do not meet the criteria shall be removed from the Project. The speed of traffic through work limits will be determined by the Town of Hudson. Channelization, if required, will consist of the use of proper temporary pavement markings, reflectorized plastic drums, signing, barricades and other public control devices in order to facilitate traffic flow. Positioning, adjusting and re-positioning of all devices shall be considered incidental to this contract. All traffic control devices shall be removed immediately when no longer needed. The Contractor shall be responsible for furnishing, installing, relocating and maintaining all traffic control devices as shown on the plans or required by the Town of Hudson, including but not limited to, safety signing, drums, cones, Type III barricades, flashing arrow boards and temporary pavement marking.

PROPERTY ACCESS

The Contractor shall provide and maintain access at all times to all properties abutting the work. Final pavement on the public ways shall be performed after all other work is finished. The Contractor may be required to install temporary measures across excavated areas of sidewalk to allow safe access to buildings and/or storefronts. Such measures will require approval from the Town of Hudson and the Engineer prior to installation. The Contractor shall notify an abutter a minimum of 24 hours in advance of any work to be performed adjacent to property of said abutter and shall notify the abutter / resident of any periodic access restrictions. The Contractor shall notify an abutter a minimum of 48 hours in advance of any work to be performed adjacent to property of said abutter that will disrupt or prevent access to the property or the ability to park their vehicle in front of or within an established driveway for said property.

SCHEDULE

The Contractor shall submit a comprehensive construction schedule to the Owner for review due upon issuance of the Notice to Proceed at least ten (10) days prior to the start of work. The construction schedule shall demonstrate in detail the means by which the Contractor will perform the work specified herein in the time allotment stated in the Contract Agreement. The Contractor shall not begin any work until the Engineer has reviewed and approved the submitted schedule.

The construction schedule shall contain all significant tasks with anticipated start date and end date. The schedule shall identify landmark tasks, critical tasks, dependent tasks and duration for each task in days. The Contractor may be required to submit an updated schedule each week. The updated schedule shall include all information described above. If the updated schedule indicates that a delay is anticipated in the final end date, the Contractor shall submit to the Engineer/Owner a written reason for the delay, possible remedy, and justification for the new end date. The Engineer/Owner shall review the statement to determine if the Contractor is responsible for the delay. If found responsible, the Contractor shall be fined in accordance with the General Conditions. If the Contractor is deemed not responsible, the contract duration will be extended in accordance with the General Conditions.

TECHNICAL SPECIFICATIONS / ITEMS:

All items of work in this contract shall be governed by the "Commonwealth of Massachusetts, Department of Public Works, Standard Specification for Highways and Bridges", dated 1988, including the latest amendments and addenda thereto:

ITEM 129.0 MILLING (Entire road) - ASPHALT EXCAVATION-COLD PLANE PER SQUARE YARD

The work done under this item shall consist of removing, Bituminous Concrete by Cold Planer directed by the Engineer, with the work conforming with the relevant provisions of Section 120.66.

It shall be the Contractor's responsibility to properly deliver and dispose of all material excavated or produced under this item at the Hudson DPW. All milled material shall be the property of the Town of Hudson.

Cold planning operations shall be performed at locations shown on the plans and at locations determined by the Designated Agent to facilitate bituminous concrete overlay installation. The depth of cold planing shall be 1 to 1 ½ inches or as necessary to meet the proposed elevation of the roadway. The average width of cold planning will be an average of 4-foot on the gutter lines or as specified by the Town.

Bituminous Concrete Cold Planing will be paid for at the contract unit price per square yard under the item. Said unit price shall include full compensation for all labor, equipment and materials and proper disposal. Repair of existing broken berms is not contractor responsibility, if the contractor breaks a berm during mill / overlay operations- they are expected to repair the berm at contractor's expense as specified in ITEM 572.2.

ITEM 129.1 7-FOOT GUTTER MILLING - ASPHALT EXCAVATION-COLD PLANE PER SQUARE YARD

The work done under this item shall consist of removing 7-Foot wide gutter area of the Bituminous Concrete by Cold Planer directed by the Engineer, with the work conforming with the relevant provisions of Section 120.66.

It shall be the Contractor's responsibility to properly deliver and dispose of all material excavated or produced under this item at the Hudson DPW. All milled material shall be the property of the Town of Hudson.

Cold planning operations shall be performed at locations shown on the plans and at locations determined by the Designated Agent to facilitate bituminous concrete overlay installation. The depth of cold planing shall be 1 to 1 ½ inches or as necessary to meet the proposed elevation of the roadway. The average width of cold planning will be an average of 7-foot on the gutter lines or as specified by the Town.

Bituminous Concrete Cold Planing will be paid for at the contract unit price per square yard under the item. Said unit price shall include full compensation for all labor, equipment and materials and proper disposal.

ITEM 222.0 FRAME AND GRATE (OR COVER) EACH

The work done under this item shall include the removing of the existing frame and grate (or cover), furnishing, installing, and setting of the new catch basin frame and grate (or manhole frame and cover) to match the newly paved road grade as directed by the Engineer. The new castings shall conform to the Hudson D.P.W. Specification HDPW-VII and to the relevant provisions of Section 220.0 (See Appendix 1 for casting specifications).

Do not begin paving work until deficient base material areas and any utility trenches have been corrected and are ready to receive paving. Paving shall not be applied until the Engineer inspects and approves the finished base. When an existing surface is identified with lack of sufficient binder course, such irregularities may be eliminated by an adequate placing and compaction of HMA mixture to furnish a surface with true contour and grade before placing any specified course of mixture.

Check all frames, covers, grates, water valve boxes and other miscellaneous castings that are located in the proposed pavement areas to ensure that all have been correctly positioned and set to the proper slope and elevation. All covers and grates shall be set flush with the required finished surface. No depressions or mounds will be permitted in the pavement to accommodate inaccuracies in the setting of castings.

The Contractor shall furnish, set, and maintain all line and grade stakes necessary to guide the automated grade control equipment. Where required these control stakes shall be maintained by the Contractor and used throughout the operations, from the grading of the subbase material up to and including the final layers of the pavement.

Adequate artificial lighting shall be provided during night placements. Hauling over freshly placed material shall not be permitted until the material has been compacted, as specified, and allowed to cool to an internal temperature of 140°F minimum.

Proper precautions shall be taken to prevent damage by construction operations to edges adjacent to the hot mix asphalt. These edges may be, but are not limited to, gutters, catch basins, curbs, concrete structures, and hot mix asphalt concrete. If damage occurs, repairs shall be made to the satisfaction of the Engineer with no additional payment.

If and when there are low areas left from the milled surface or prior deficiencies in the pavement being overlaid, it is understood that there may need to be a thicker placement of the top course to level the surface prior to compaction.

We anticipate a small percentage of driveway aprons to be milled and overlaid (each about 5 ft-average depth x 11 ft-average width). Paving quantities (Item 460.0) include the tonnage needed for the few driveway keyways. The Town will work with the Contractor to identify those driveways.

Bituminous concrete will be paid for at the contract unit price per ton under the item Class I Bituminous Concrete Type I-1, and shall be the actual and verified tonnage, complete in place, approved and shall include full compensation for labor, equipment, and materials.

Price Adjustment

This price adjustment is inserted in the contract because the national and worldwide energy situation has made the future cost of fuel unpredictable. This adjustment will provide for either additional compensation to the Contractor or repayment to the municipality depending on an increase or decrease in the average price of liquid asphalt.

This provision applies to all hot mix asphalt mixtures containing liquid asphalt.

The Base Price of Liquid Asphalt on the project will be a fixed price and shall be as stated in this contract per Ton, which includes State Tax.

The Contract Price of the Hot Mix Asphalt Mixture will be paid under the respective item in the contract. The price adjustment, as herein provided, upward and downward, will be made as work is performed, using the most recent previous price adjustment Item until the applicable Period Price is established.

The Price Adjustment will be based on the variance in price for the Liquid Asphalt component only from the Base Price to the Period Price. It shall not include transportation or other charges.

The Period Price for Hot Mix Asphalt for a two month period (FOB Terminal) will be determined and published by the Massachusetts Highway Department (www.mhd.state.ma.us) by averaging the prices posted at the beginning, middle, and end of each two month period by two or more suppliers.

The asphalt content for Hot Mix Asphalt Mixtures shall be 5.5% (0.055) by weight regardless of percentages established by the Job Mix Formula as described in Material Section M3.11.03 of the Standard Specification.

The Price Adjustment will be a separate payment item. It will be determined by multiplying the number of tons of Hot Mix Asphalt placed during each previous two month period by asphalt content percentage (0.055) times the variance in price between Base Price and Period Price of asphalt.

The price adjustment will be paid only if the variance from the base price is 5% or more for a monthly period. The complete adjustment will be paid in all cases with no deduction of the 5% from either upward or downward adjustments.

No price adjustment will be allowed beyond the completion date of the contract, unless there is an approved extension of time by the municipality.

ITEM 572.2 CLASS I BITUMINOUS CONCRETE BERM TYPE 2 PER TON

The work done under this item shall include the supplying and placement of Bituminous Concrete Berm Type 2 as directed by the Engineer with the work and materials conforming to the relevant provisions of Section 470.0.

If included in the scope of work, Bituminous Concrete Berm, Type 2 will be paid for at the contract unit price per ton under the item Class I Bituminous Concrete Berm, Type 2, and shall be the actual and verified tonnage, complete in place, approved and shall include full compensation for labor, equipment, and materials.

Price Adjustment

See Item 460.0 for detail.

ITEM 703.0 CLASS I BITUMINOUS CONCRETE DRIVEWAY/SIDEWALK PER TON

The work done under this item shall consist of the supplying and placement of 3" of Bituminous Concrete Type I-1, Top Coarse, on the prepared existing driveway opening and sidewalks as directed by the Engineer with all work and materials conforming to the relevant provisions of Section 701.62.

Bituminous Concrete Driveway/Sidewalk will be paid for at the contract unit price per ton under the item Class I Bituminous Concrete Driveway/Sidewalk, and shall be the actual and verified tonnage, complete in place, approved and shall include full compensation for labor, equipment, and materials.

Price Adjustment

See Item 460.0 for detail.

ITEM 851.0 SAFETY SIGNING FOR CONSTRUCTION OPERATIONS PER LUMP SUM

The work done under this item shall include the furnishing, erecting and maintaining of Safety Signing for construction operations at the approximate locations delineated in the Construction Safety Signing Plan contained in Appendix 1 of these specifications. The work and materials under this item shall conform with the relevant provisions of Section 580.0, and with the details contained in Appendix 1. Any usage of temporary ramps and donuts after milling operations shall be included in this item.

Throughout the milling operation protection shall be provided around existing catch basin inlets, manholes, utility valve boxes, and any similar structures. Any damage to such structures as a result of the milling operation is the Contractor's responsibility and shall be repaired at the Contractor's expense. To prevent the infiltration of milled material into the storm sewer system the Contractor shall take special care to prevent the milled material from falling into the inlet openings or inlet grates. Any milled material that falls into inlet openings or inlet grates shall be removed at the Contractor's expense. All raised structures post milling operations shall be painted florescent orange / cones / barrels utilized to prevent any traffic / vehicular issues. All protective and safety measures taken shall be included in this item.

Safety signing for construction operations shall be paid for at the contract unit price per square foot under the item Safety Signing, and shall include full compensation for labor, signs, posts, materials, and equipment.

ITEM 860.04 4" REFLECTORIZED WHITE LINE (PAINTED) PER LINEAR FOOT

The work done under this item shall consist of furnishing materials and the application of 4" reflectorized white painted lines for cross walk delineation, as directed by the Engineer, with the work conforming to the relevant provisions of Section 860.0.

Crosswalk line painting will be paid for at the contract unit price per linear foot under the item for Reflectorized white Line (Painted) and shall include full compensation for labor, equipment and materials.

ITEM 860.12 12" REFLECTORIZED WHITE LINE (PAINTED) PER LINEAR FOOT

The work done under this item shall consist of furnishing materials and the application of 12" reflectorized white painted lines for cross walk delineation, as directed by the Engineer, with the work conforming to the relevant provisions of Section 860.0.

Crosswalk line painting will be paid for at the contract unit price per linear foot under the item for Reflectorized white Line (Painted) and shall include full compensation for labor, equipment and materials.

ITEM 861.041 4" SINGLE YELLOW CENTER LINES (SYCL) REFLECTORIZED (PAINTED) PER LINEAR FOOT

The work done under this item shall consist of furnishing materials and the application of 4" SYCL reflectorized yellow painted traffic Lines as directed by the Engineer with the work conforming to the relevant provisions of Section 860.0.

Traffic line painting shall be paid for at the contract unit price per linear foot under the item for the particular type of line painting, and shall include full compensation for labor, equipment and materials.

ITEM 861.042 4" DOUBLE YELLOW CENTER LINES (DYCL) REFLECTORIZED (PAINTED) PER LINEAR FOOT

The work done under this item shall consist of furnishing materials and the application of 4" DYCL reflectorized yellow painted traffic Lines as directed by the Engineer with the work conforming to the relevant provisions of Section 860.0.

Traffic line painting shall be paid for at the contract unit price per linear foot under the item for the particular type of line painting, and shall include full compensation for labor, equipment and materials.

APPENDIX 1: MISCELLANEOUS DETAILS

CONTENTS	PAGE
CONSTRUCTION SAFETY SIGNING PLAN	P-2, P-3
HOT MIX ASPHALT BERM	P-4
SIDEWALK THROUGH DRIVEWAYS	P-5, P-6
CONCRETE COLLAR DETAIL	P-7
CATCH BASIN FRAME & GRATE CASTING	P-8
MANHOLE FRAME & COVER CASTING	P-9, P-10, P-11

THIS SIGN TO BE USED FOR THIS PROJECT

(1)

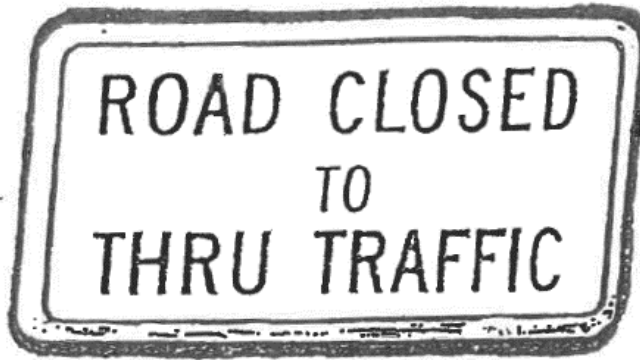

30"

60"

(2)

4 SIGNS

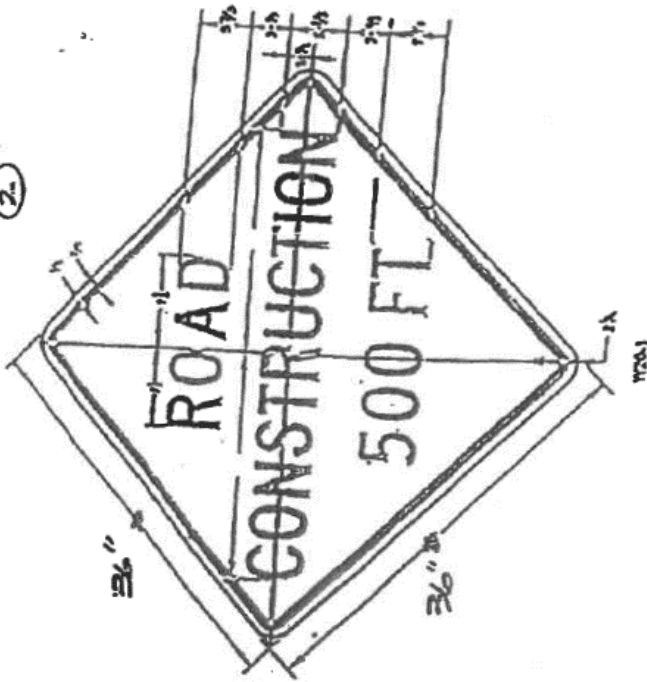

(3)

























COLORS

LEGEND - BLACK IRON ACFLI
BACKGROUND - ORANGE

SIGN DETAILS

THE LOCATIONS OF SAFETY SIGNING SHALL BE DETERMINED BY THE ENGINEER. THE CONTRACTOR SHALL BE RESPONSIBLE FOR ANY NECESSITATED DETOUR SIGNING, AND SHALL CONSULT HUDSON POLICE, FIRE, SCHOOL DEPTS. WITH AT LEAST ONE DAY NOTICE. REQUESTS FOR POLICE DETAILS SHALL BE MADE TO THE ENGINEER WITH AT LEAST ONE DAY NOTICE. DISRUPTION TO RESIDENTS SHALL BE MINIMIZED.

SIGN LEGEND

 W3-2A (36" x 36")	 W9-2L (36" x 36")	 W20-1 (48" x 48") (500) (1000) (1500) (1/2 MILE) (1 MILE)	 W30-8(R&L) (36" x 36")	 G20-2a (36" x 18")	 W20-6d (48" x 48")	 W20-5(R&L) (48" x 48")
 W4-1 (30" x 30")	 W4-2(R&L) (36" x 36")	 W5-1 (36" x 36")	 R11-2 (48" x 30")	 M4-10R (48" x 18")	 W21-5 (30" x 30")	
 R1-2 (36" x 36" x 36")	 W1-4(R&L) (30" x 30")	 W20-2 (48" x 48") (500) (1000) (1500) (1/2 MILE) (1 MILE) (AHEAD)	 W20-3 (48" x 48") (AHEAD) (500)	 W20-8 (36" x 36")	 G20-1 (36" x 18")	 W20-4 (48" x 48") (1000) (1500)
 R11-4 (36" x 36")	 R9-9 (24" x 12")	 R9-11 (36" x 30")	 W11-2 (30" x 30") SUPPLEMENT WITH W16-7P	 W16-7P (24" x 12")		

NOTE: ALL SIGNING MUST COMPLY WITH THE U.S./FHWA MANUAL OF UNIFORM TRAFFIC CONTROL DEVICES-2000, AND BE FABRICATED WITH HIGH INTENSITY ENCAPSULATED LENS REFLECTIVE SHEETING TYPE III OR IV PER MHD SECTION M9.30.0 SPECIFICATION

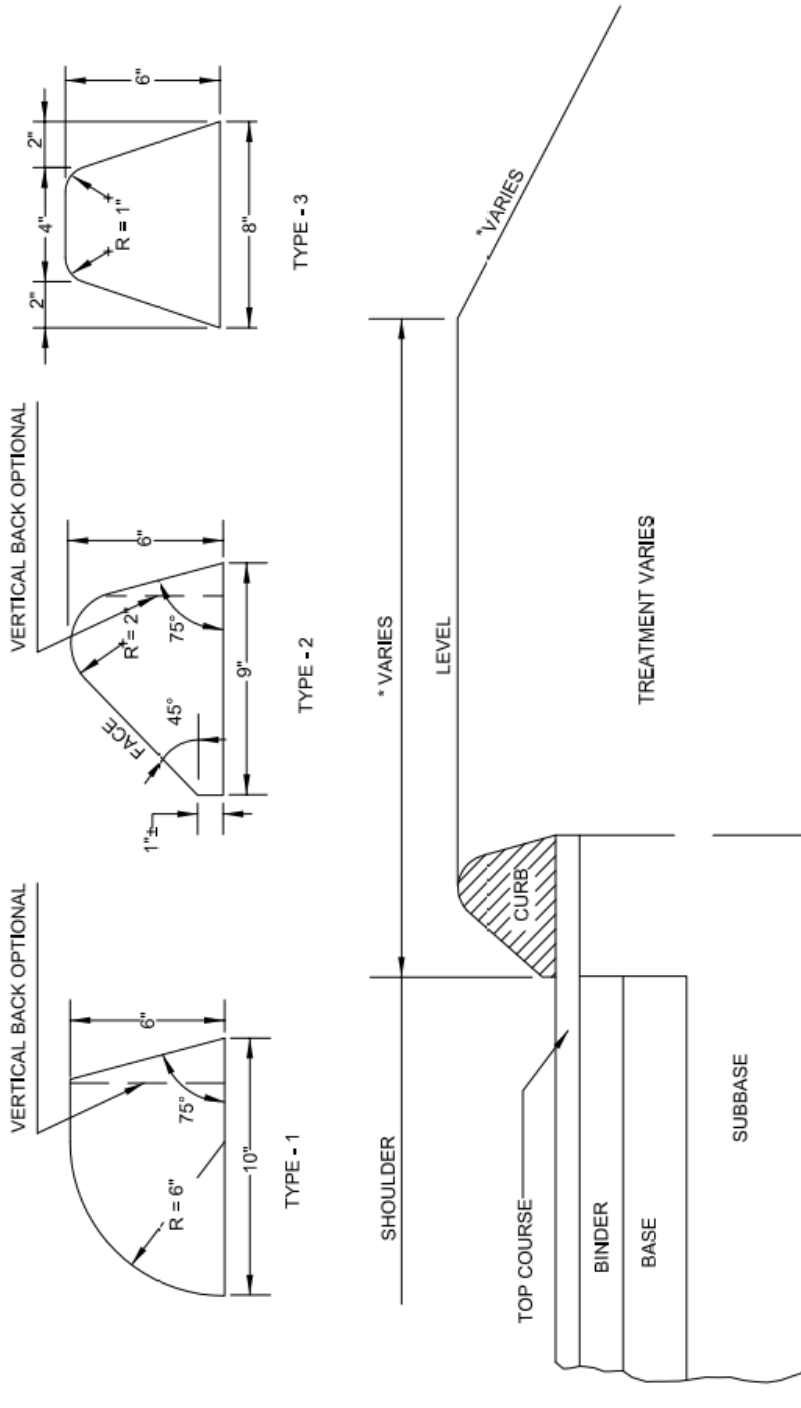

HOT MIX ASPHALT CURBS

METHOD OF SETTING-TYPICAL FOR ALL TYPES

* SEE TYPICAL SECTIONS FOR PROJECT.

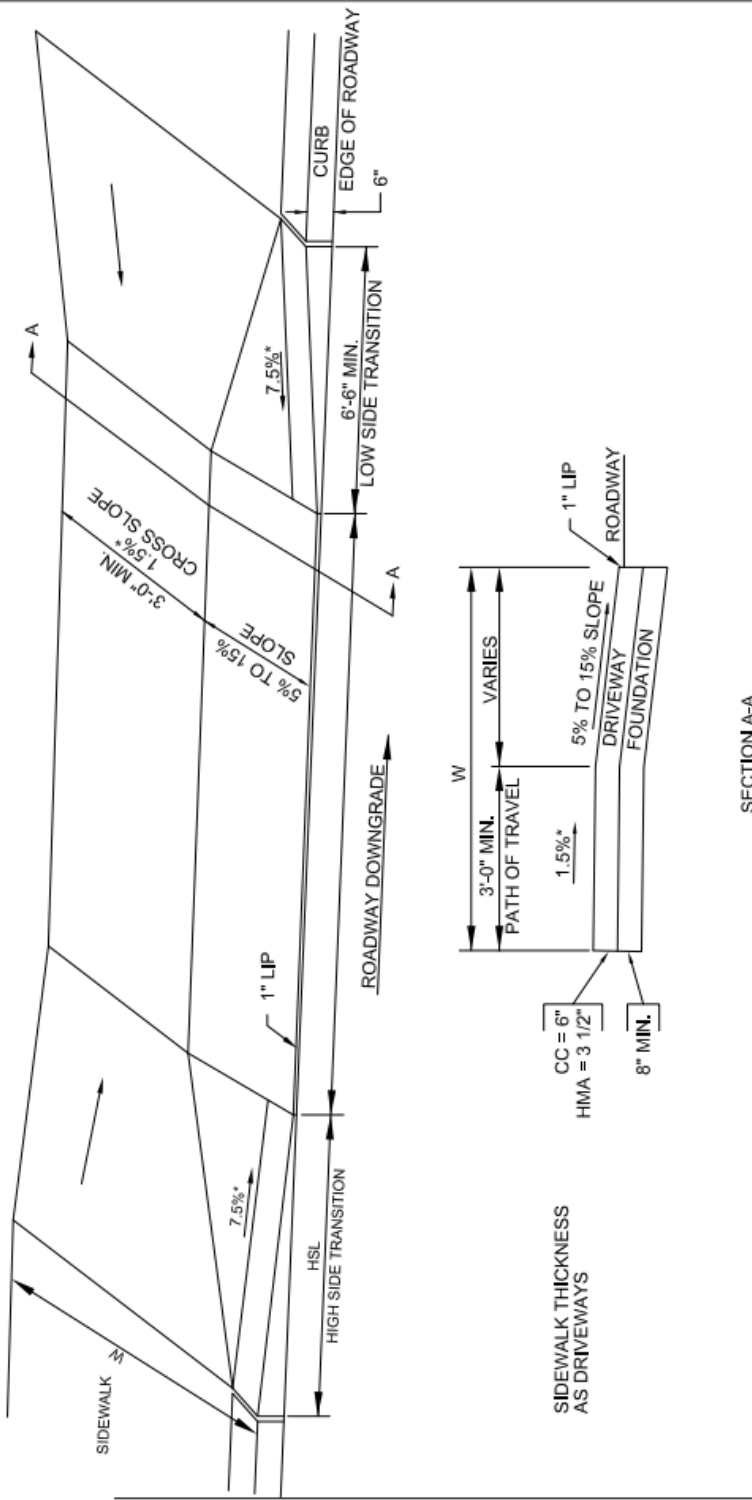

**SIDEWALK THROUGH DRIVEWAYS
WITHOUT CURB RETURNS**

LEGEND

- HSL = HIGH SIDE TRANSITION LENGTH. SEE E 107.9.0
- W = SIDEWALK WIDTH
- . = TOLERANCE FOR CONSTRUCTION ±0.5%
- CC = CEMENT CONCRETE
- HMA = HOT MIX ASPHALT

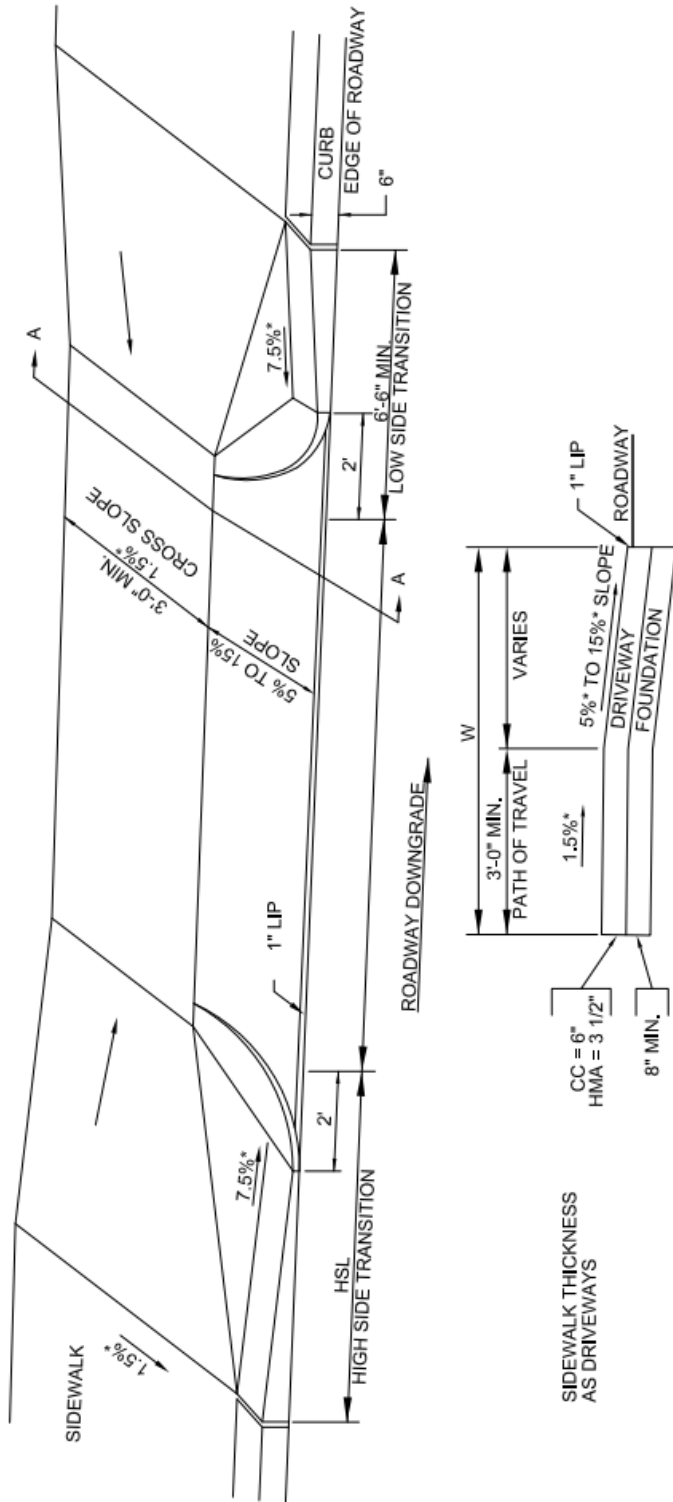

**SIDEWALK THROUGH DRIVEWAYS
WITH CURB RETURNS
2' CURB CORNERS**

SECTION A-A

LEGEND

- HSL = HIGH SIDE TRANSITION LENGTH. SEE E 107.9.0
- W = SIDEWALK WIDTH
- * = TOLERANCE FOR CONSTRUCTION ±0.5%
- CC = CEMENT CONCRETE
- HMA = HOT MIX ASPHALT

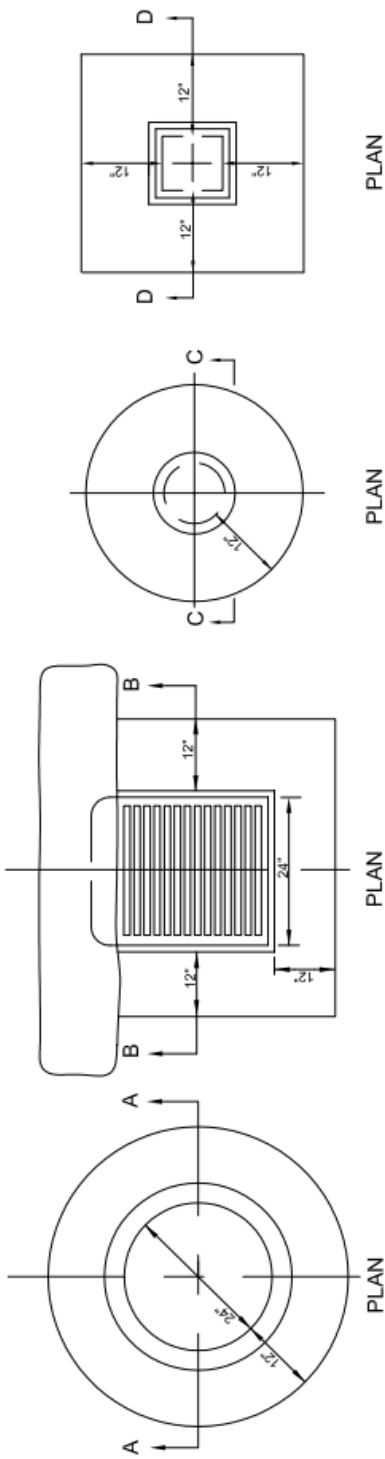

Note: Parallel bar grates not allowed in Hudson, MA

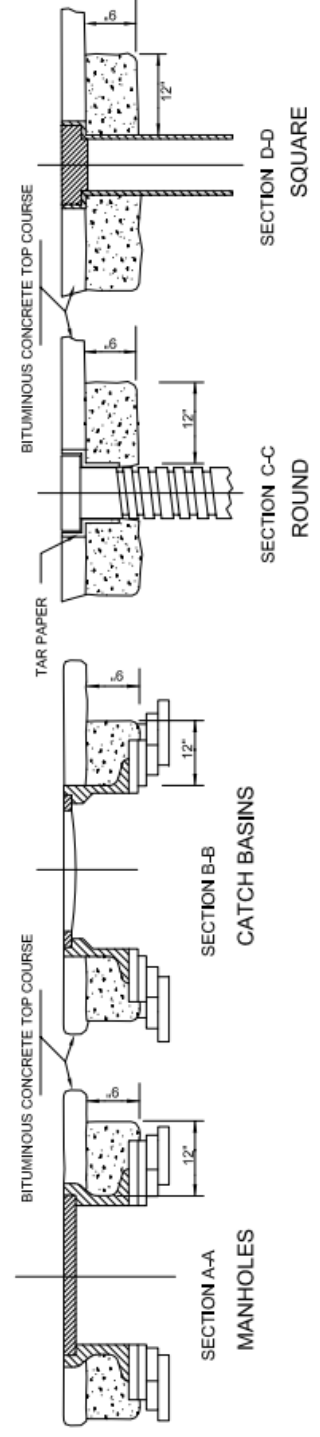

WATER SERVICE BOXES

CONCRETE COLLARS

- NOTES:
1. COLLARS TO BE 4000PSI CEMENT CONCRETE MASONRY REGULAR OR H.E.S. AS DIRECTED. (SEE MASSDOT SPECIFICATIONS FOR DESIGN REQUIREMENTS). (IF HAND MIXED, SEE LATEST STANDARD SPECIFICATIONS).
 2. NO CONCRETE REQUIRED IN CONCRETE PAVEMENT.

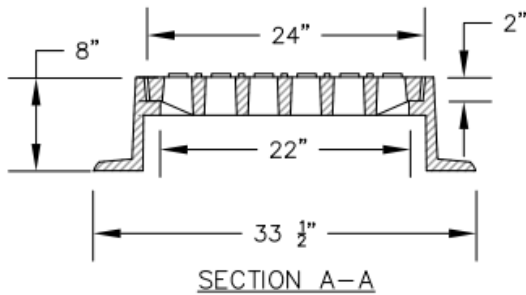
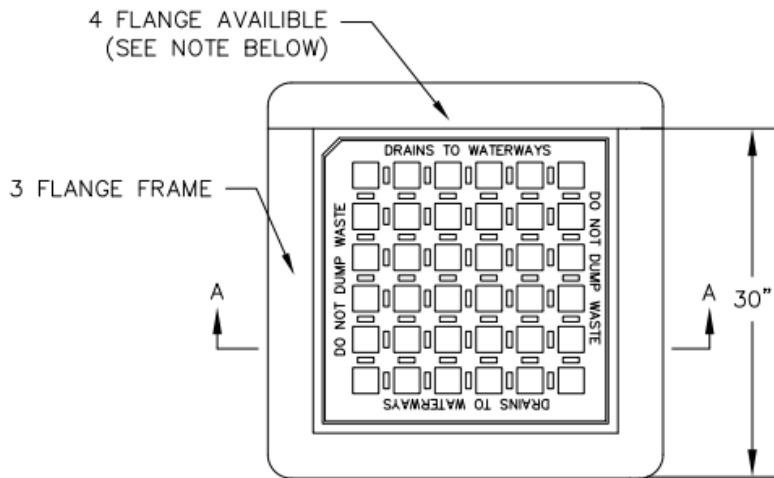

NOTES:

1. FRAME EJ CATALOG NO. 5546Z
GRATE EJ CATALOG NO. 5520M5
OR APPROVED EQUAL.
2. 3 FLANGE FRAMES TO BE USED WHERE INLET IS ADJACENT TO CURB STONES, 4 FLANGE FRAME TO BE USED ELSEWHERE.
3. "DO NOT DUMP WASTE, DRAINS TO WATERWAYS" SHALL BE FORGED INTO THE GRATE.

STANDARD DETAILS

DRAINAGE

CATCH BASIN
FRAME & GRATE

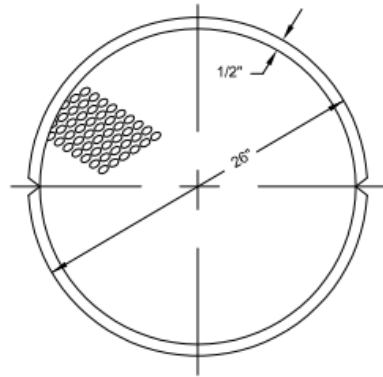

STANDARD COVER
FOR COVER DETAILS SEE DRAWING E 202.8.0

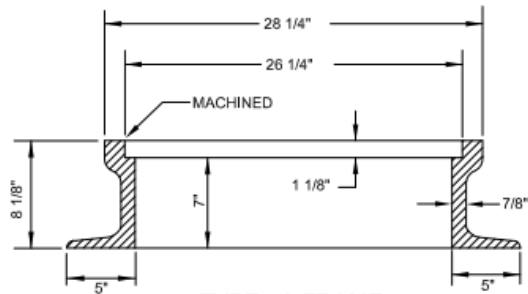
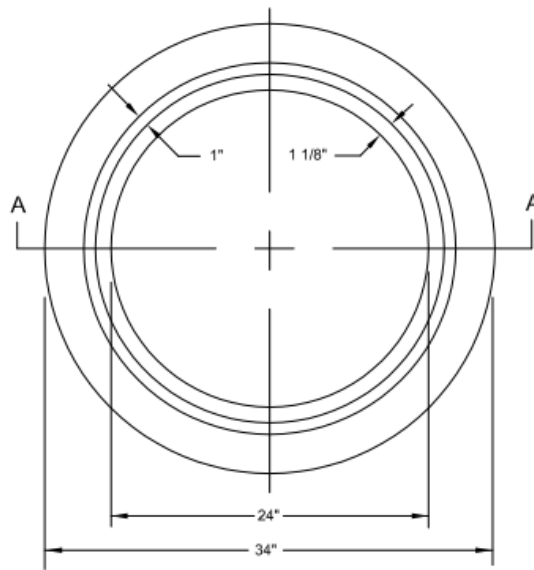

TYPE - A FRAME

NOTES:

1. MINIMUM MASS - 265 LBS.
2. MATERIAL - CAST IRON - SEE STANDARD SPECIFICATIONS WITH NO BLACK ASPHALT COATING ALLOWED

**MANHOLE FRAME AND
COVER - A FRAME**

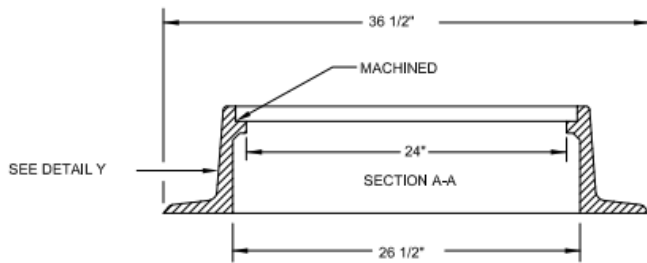
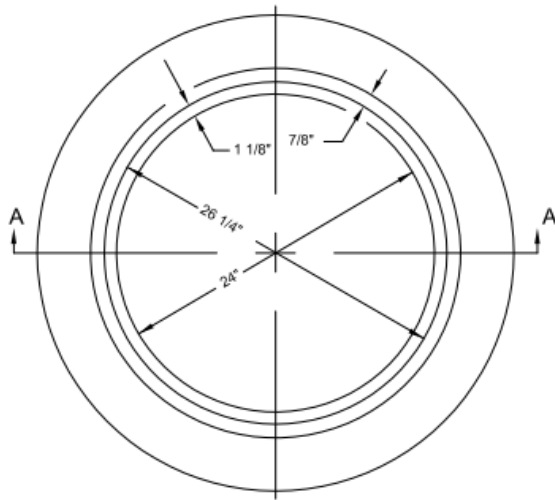

TYPE - B FRAME

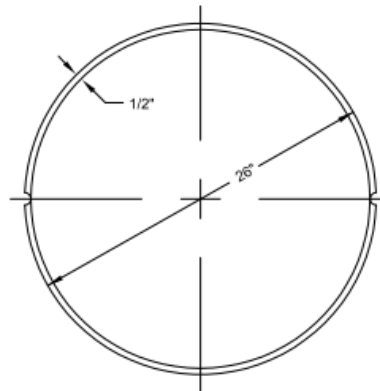
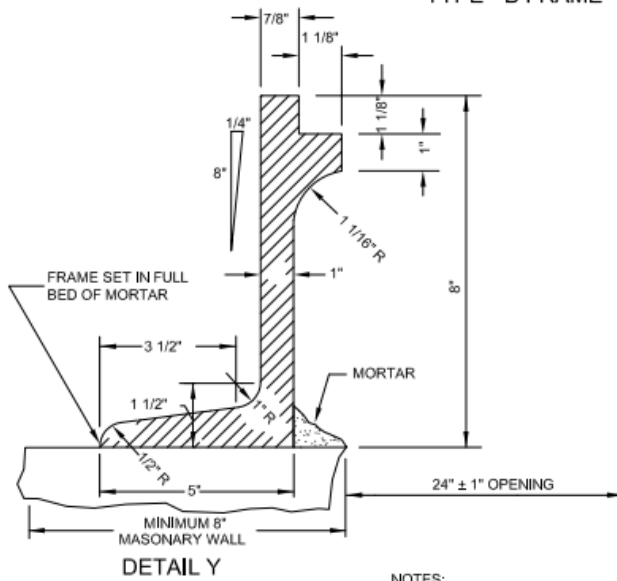

STANDARD COVER
FOR COVER DETAIL, SEE DRAWING E 202.8.0

NOTES:

1. MINIMUM FRAME MASS 265 LBS.
2. MATERIAL - CAST IRON - SEE STANDARD SPECIFICATIONS WITH NO BLACK ASPHALT COATING ALLOWED

MANHOLE FRAME AND COVER - B FRAME

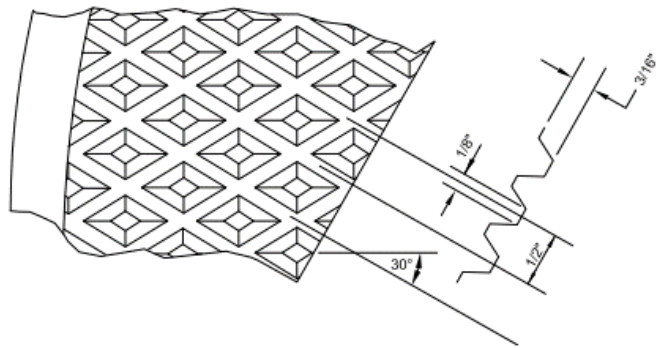

DETAIL OF TREAD

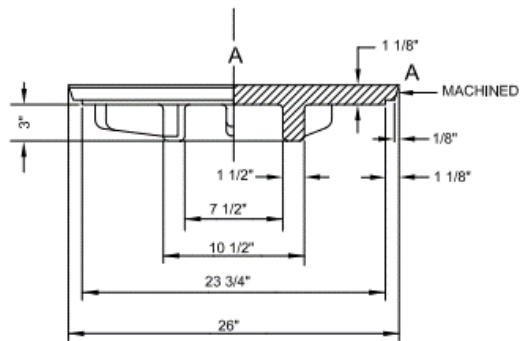
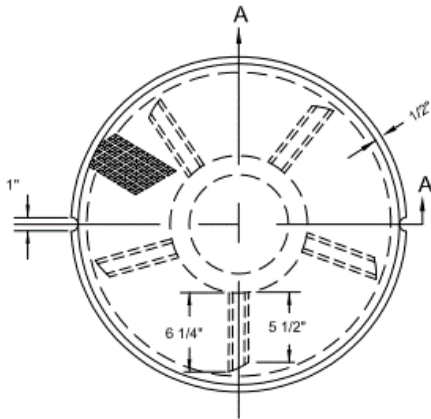

MANHOLE COVER FOR TYPE A & B FRAMES

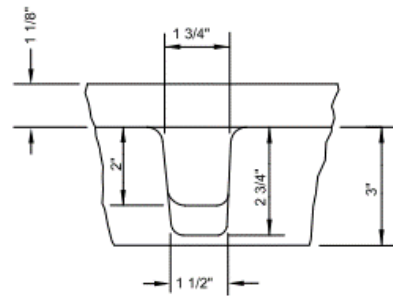

DETAIL OF FIN

NOTES:

1. MINIMUM COVER MASS - 200 LBS.
2. MATERIAL - CAST IRON - SEE STANDARD SPECIFICATIONS WITH NO BLACK ASPHALT COATING ALLOWED



MANHOLE COVER DETAILS

DATE OF ISSUE
OCTOBER 2017

DRAWING NUMBER
E 202.8.0

Certificate of Tax Compliance

Pursuant to Massachusetts General Law Chapter 62C, §49A, I hereby certify under penalties of perjury that I have, to the best of my knowledge and belief, filed all state tax returns and paid all state taxes required under law.

Social Security of Federal I. D. Number:

Signature: Individual or Corporate Officer

Date

Please Print:

Corporate Name: _____

Address: _____

P. O. Box: _____

City, State, Zip Code: _____

*Your Social Security Number or Federal Identification Number will be furnished to the Massachusetts Department of Revenue to determine whether you have met tax filing or tax payment obligations. Proposers who fail to correct their non-filing or delinquency will not have a contract or other agreement issued, renewed, or extended. This request is made under the authority of M.G.L. Ch. 62C, §48A.

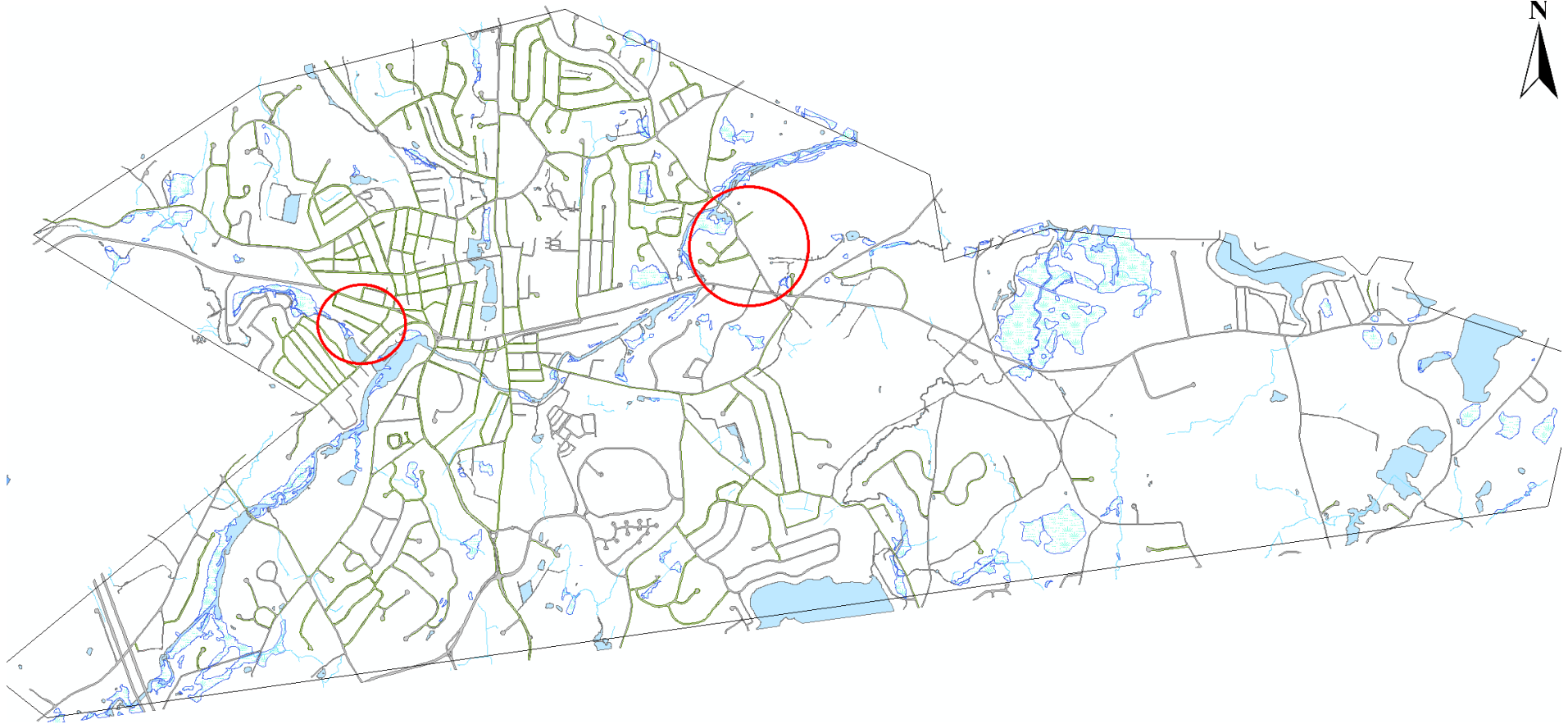

PROJECT A:

1. Green St from Central St to River St
2. Florence St from River st to Elm Dr
3. Elm Dr from Florence St to Central St
4. Cox St from Assabet river Bridge to Main St



Green St from Central St to River St-
Does not include the parking lot abutting
the river in the South.



Florence Street from River street to Green Street and then Green street to Elm Drive





Cox Street including the fork at the Main street intersection and a small portion of the entryways to municipal buildings and intersecting roads.

